

LITETRONICS®

LED Flat Panel

Installation Instructions

For 1'x4', 2'x2', and 2'x4' LED Flat Panels (FP Series)



PLEASE READ THESE INSTRUCTIONS BEFORE INSTALLATION

SAFETY INSTRUCTIONS AND WARNINGS

WARNING:

READ CAREFULLY BEFORE INSTALLING FIXTURE. RETAIN THESE INSTRUCTIONS FOR FUTURE REFERENCE.

Litetronics fixtures must be wired in accordance with the National Electrical Code and all applicable local codes.

Risk of fire or electric shock. Flat Panel installation requires knowledge of luminaires electrical systems. If not qualified, do not attempt installation. Contact a qualified electrician.

Be certain electrical power is OFF before and during installation and maintenance.

Flat Panel must be connected to a wiring system with an equipment – grounding conductor.

Make sure the supply voltage is same as the rated luminaire voltage

Only those open holes indicated in the photographs and/or drawings may be made or altered as a result of this kit installation. Do not leave any other open holes in an enclosure of wiring or electrical components.

To prevent wiring damage or abrasion, do not expose wiring to edges of sheet metal or sharp objects.

No user serviceable parts inside of Flat Panel.

Suitable for damp locations.

Suitable for 9/16" or 15/16" Flat Tee Grid in both Insulated Ceilings and Non-insulated Ceilings. Access above ceiling required.

Vapor barrier must be suitable for 90° C.

Fixture to be independently supported to building structure.

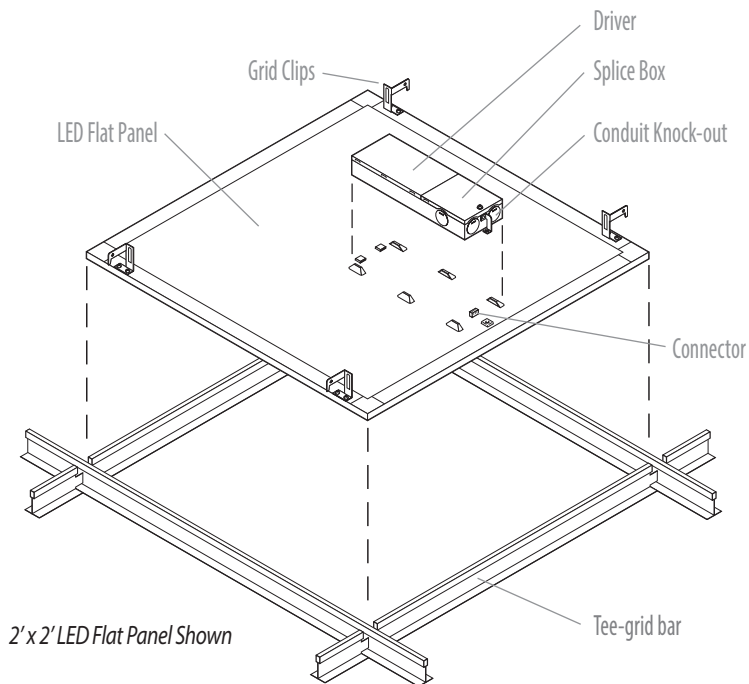

Note: Driver with splice box can be pre-wired before assembly to Flat Panel.

TOOLS TYPICALLY USED FOR INSTALLATIONS



Wire Stripper
(optional)

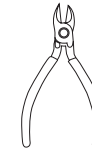

Wire Cutter
(optional)

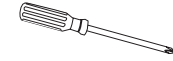

Phillips Screwdriver

WHAT COMES IN THE BOX

LED Flat Panel base product comes with following standard parts:



(1) LED Flat Panel



(1) Driver with Splice Box

Note: (3) Wire Nuts and (1) Thumb Screw included in Splice Box



(1) Instructions

Before Installation, carefully remove Flat Panel and Driver from the packaging. Inspect product for defects due to shipping.

LED FLAT PANEL RECESSED INSTALLATION

READ ALL INSTRUCTIONS BEFORE BEGINNING INSTALLATION

1. Turn off power at panel
2. Pre-assemble driver to Flat Panel.

Note: The features of the mating surface of driver and panel.

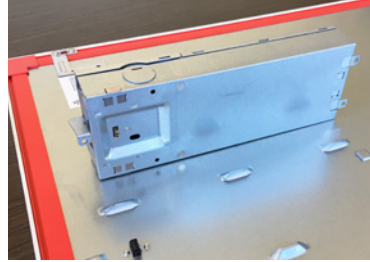

3. With driver at a slight angle, slide two tabs into raised slots on panel. Once the tabs are seated, push the driver down into position. This will dock the connector on the driver with the Flat Panel.



4. Secure driver in position by rotating lever until it locks into raised slot on Flat Panel.

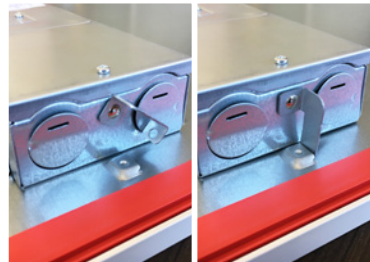

5. Prepare Flat Panel to install. Firmly bend grid clips up and out at edge of panel.

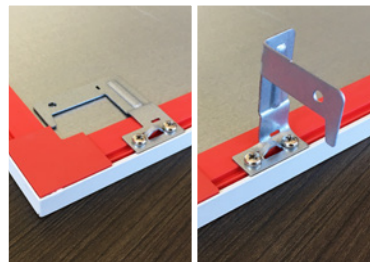

LED FLAT PANEL RECESSED INSTALLATION

6. Remove ceiling tile in chosen location for Flat Panel. Attach branch power wire from conduit to driver.

Note: The orientation of the driver and conduit knock-outs to ensure they face the appropriate direction for electrical splices. This is especially important for 1'x4' and 2'x4' installations.



7. Tilt and raise the panel up into the empty grid space, then lower until grid clips catch on tee-grid bar. Support the Flat Panel to the building structure with support wires (third party) using the hole in the grid clip.

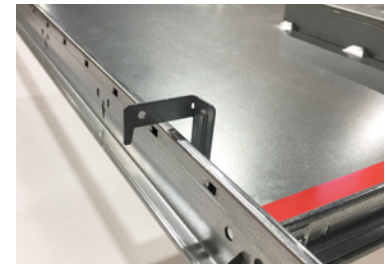

8. Remove cover of splice box.

Note: Thumb screw and wire nuts for final assembly are included in bag inside splice box.

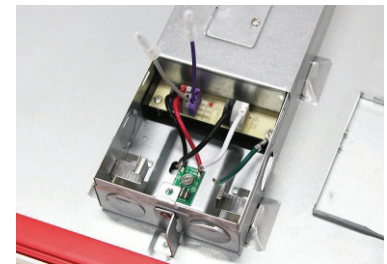

9. Remove one conduit knock-out from driver.

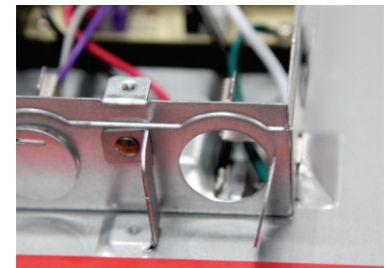

LED FLAT PANEL RECESSED INSTALLATION

10. *Note: Markings on Printed Circuit Board (PCB) for AC-L wire (Black), AC-N wire (White) and position of the ground wire (Green).*

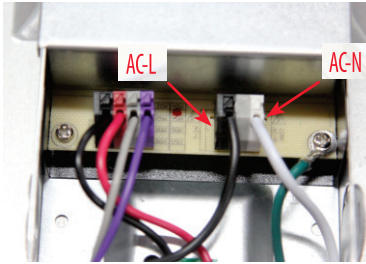

11. Connect incoming wires in splice box on driver wires using wire nuts. Using wire nuts provided, connect stripped end of AC-L wire (Black) to stripped end of Power Wire - L (Black). Push wires into wire nuts, and twist on. Follow same steps to connect stripped ends of AC-N wire (White) and Power Wire - N (White) and again for the stripped end of green ground wire from splice box.
Note: Wire nuts accept 18-12 AWG. If dimming is required, connect dimming lines to corresponding wire leads with wire nuts, per wiring diagram.

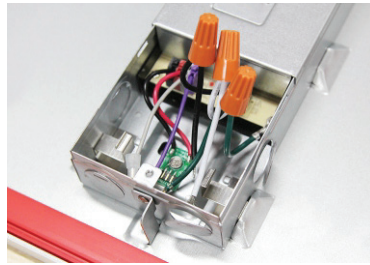

12. Complete assembly. Push wires and wire nuts into junction box. Use provided thumb screw to secure access plate to splice box.

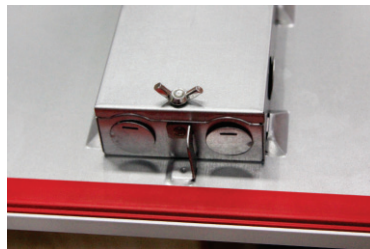

13. Replace ceiling tiles.
14. Turn on power and you are done.

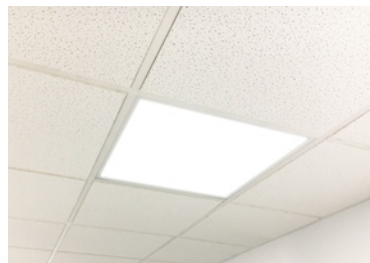

LED FLAT PANEL RECESSED INSTALLATION

WIRING DIAGRAM

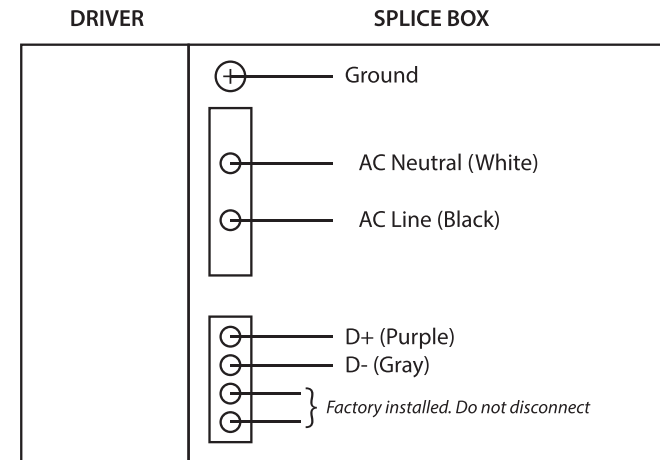

D+/D- used for connection to 0-10V dimming lines

Thank you for choosing

LITETRONICS®

6969 W. 73rd Street
Bedford Park, IL 60638

WWW.LITETRONICS.COM

CustomerService@Litetronics.com or 1-800-860-3392

