

PROJECT:	
CATALOG #	
TYPE:	DATE:

LED LIGHT PANEL

with Field-adjustable Light Output

DESCRIPTION

Combining top-of-the-line efficiency with a stylish, modern design, the LED Light Panel is an ideal solution for interior grid ceiling applications. Our standard model is equipped with field-adjustable light output, enabling the lumen output and wattage to be set to one of five specific levels based on the needs of the user. This feature enables not only the customization of light output, but also puts a cap on the amount of energy being used. Installation is simple and quick; this LED panel upgrade fits seamlessly into all standard 2' x 4', 2' x 2' or 1' x 4' grid ceiling layouts.

The LED Light Panel delivers up to 125 lumens per watt (LPW) over the course of its 100,000-hour rated life. It ensures long-term energy savings over traditional fluorescent bulbs and ballasts, as well as eliminates routine maintenance, making it perfect for updating existing grid layouts or implementing in new construction. Furthermore, it's backed by an industry-leading 10-year warranty, guaranteeing peace of mind for the life of your fixture.

FEATURES

- Field-adjustable light output
- 100,000-hour rated life
- 10-year warranty
- DLC 5.1 Premium (up to 125 LPW)
- Sealed enclosure (Bug/dust free)
- Anti-yellowing frosted diffuser
- Suitable for damp locations
- IC rated
- 0-10V Dimming
- Compatible with Emergency Battery Backup

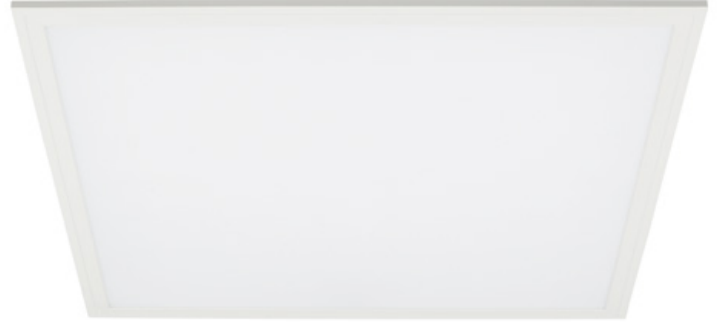

MARKETS

- Schools and universities
- Offices and municipal buildings
- Healthcare facilities and hospitals

APPLICATIONS

- Drop/grid ceilings
- Fluorescent troffers

CERTIFICATIONS



SPECIFICATIONS

Average rated life: 100,000 hours (@L70)

Warranty: 10 years

PERFORMANCE

Operating temp: -4°F to 104°F (-20°C to 40°C)

Efficacy (LPW): 125 LPW

CRI: 80

ELECTRICAL

Input voltage: 120-277V

Input frequency: 50/60Hz

PF: ≥.95

Surge protection: ANSI C82.77 compliant

Dimming: 0-10VDC ANSI C137.x compliant

Minimum dimming: 0% of rated lumen LED drive current

Aux. Voltage: N/A

Whip/Cord: None

Sensor: N/A

INDUSTRY STANDARDS/RATINGS

Location: Damp

IC: Yes

UL/ETL: UL

FCC: Yes

RoHS: Yes

DLC: 5.1 Premium

MOUNTING

Standard: T-bar grid (drop ceilings)

Wiring access: 1/2" trade size knockouts

ACCESSORIES

**Emergency Battery Backup
Surface Mounting Kit**

**Drywall Mounting Kit
Suspension Mounting Kit**

DIMENSIONS / WEIGHT

SIZE	LENGTH	WIDTH	HEIGHT
2' x 4'	47.5"	23.75"	2.8"
2' x 2'	23.75"	23.75"	2.8"
1' x 4'	47.5"	11.9"	2.8"

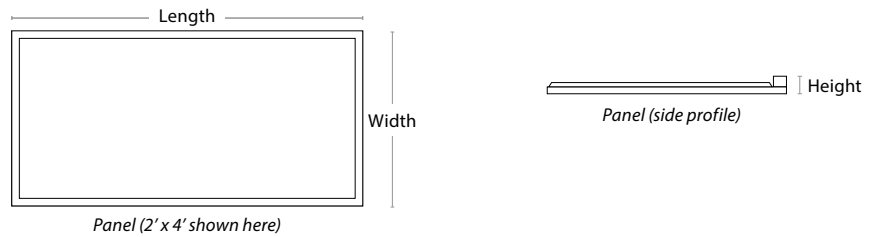

PRODUCT OVERVIEW AND INSTALLATION

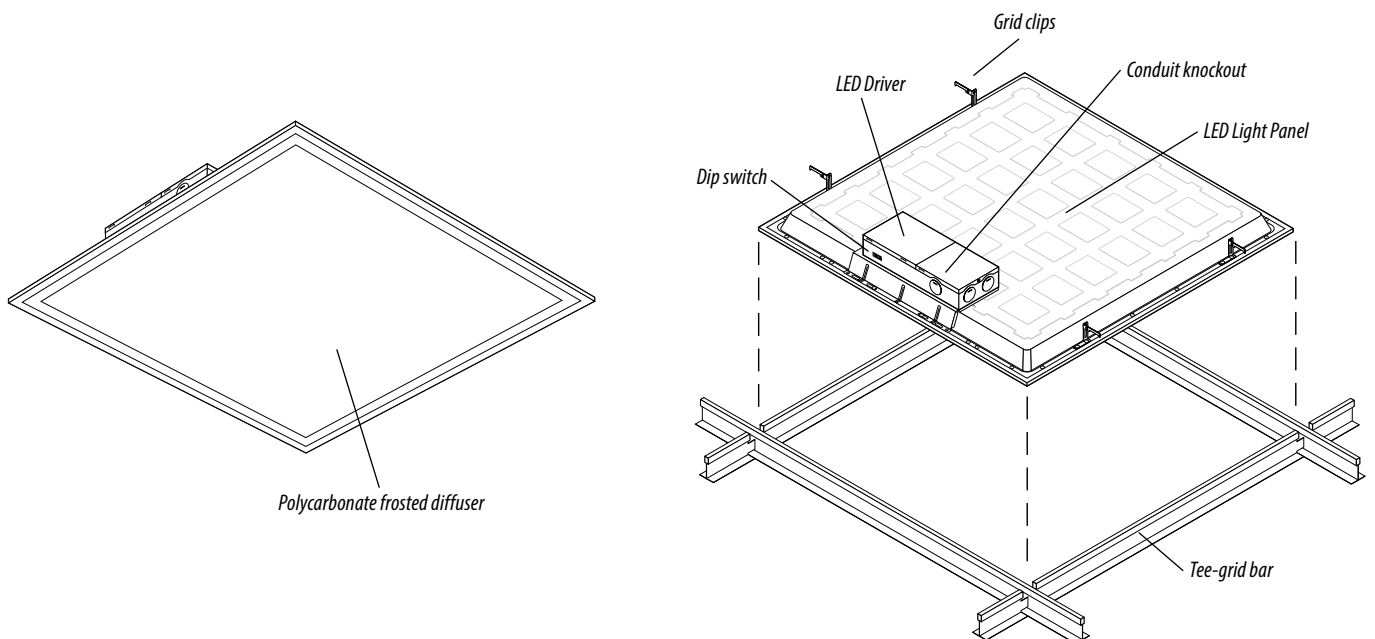

ORDERING INFORMATION

Listed below are the included wattage settings and lumens for each model number.

2' X 2'

ROOT MODEL #	DESCRIPTION		
PT235	2X2 LED Light Panel		
EXT. MODEL #	WATTAGE	CCT	LUMENS
PT23518	18	3500	2,250
PT23520*	20	3500	2,500
PT23525*	25	3500	3,125
PT23530*	30	3500	3,750
PT235*	36	3500	4,500

ROOT MODEL #	DESCRIPTION		
PT240	2X2 LED Light Panel		
EXT. MODEL #	WATTAGE	CCT	LUMENS
PT24018	18	4000	2,250
P24020*	20	4000	2,500
PT24025*	25	4000	3,125
PT24030*	30	4000	3,750
PT240*	36	4000	4,500

ROOT MODEL #	DESCRIPTION		
PT250	2X2 LED Light Panel		
EXT. MODEL #	WATTAGE	CCT	LUMENS
PT25018	18	5000	2,250
PT25020*	20	5000	2,500
PT25025*	25	5000	3,125
PT25030*	30	5000	3,750
PT250*	36	5000	4,500

2' X 4'

ROOT MODEL #	DESCRIPTION		
PT435	2X4 LED Light Panel		
EXT. MODEL #	WATTAGE	CCT	LUMENS
PT43525	25	3500	3,125
PT43530*	30	3500	3,750
PT43540*	40	3500	5,000
PT43545*	45	3500	5,625
PT435*	50	3500	6,250

ROOT MODEL #	DESCRIPTION		
PT440	2X4 LED Light Panel		
EXT. MODEL #	WATTAGE	CCT	LUMENS
PT44025	25	4000	3,125
PT44030*	30	4000	3,750
PT44040*	40	4000	5,000
PT44045*	45	4000	5,625
PT440*	50	4000	6,250

ROOT MODEL #	DESCRIPTION		
PT450	2X4 LED Light Panel		
EXT. MODEL #	WATTAGE	CCT	LUMENS
PT45025	25	5000	3,125
PT45030*	30	5000	3,750
PT45040*	40	5000	5,000
PT45045*	45	5000	5,625
PT450*	50	5000	6,250

1' X 4'

ROOT MODEL #	DESCRIPTION		
PT135	1X4 LED Light Panel		
EXT. MODEL #	WATTAGE	CCT	LUMENS
PT13518	18	3500	2,250
PT13520*	20	3500	2,500
PT13525*	25	3500	3,125
PT135*	30	3500	3,750

ROOT MODEL #	DESCRIPTION		
PT140	1X4 LED Light Panel		
EXT. MODEL #	WATTAGE	CCT	LUMENS
PT14018	18	4000	2,250
PT14020*	20	4000	2,500
PT14025*	25	4000	3,125
PT140*	30	4000	3,750

ROOT MODEL #	DESCRIPTION		
PT150	1X4 LED Light Panel		
EXT. MODEL #	WATTAGE	CCT	LUMENS
PT15018	18	5000	2,250
PT15020*	20	5000	2,500
PT15025*	25	5000	3,125
PT150*	30	5000	3,750

Each extended model # is individually listed with DLC. The highest wattage is listed under the root model #.

*Model not DLC approved.

HIGH OUTPUT

MODEL #	DESCRIPTION	WATTAGE	CCT	LUMENS
PT44070*	70W 2X4 LED Light Panel 4000K	70	4000	9,000

*Model not DLC approved.

EMERGENCY BATTERY BACKUP

MODEL #	DESCRIPTION	USAGE
EB10	10W Emergency Battery Backup	Supplies battery backup to an individual fixture for up to 90 minutes. <u>Must be ordered with EBCM or EBAM indicator module.</u>
EBCM	Ceiling-Mounted Indicator Module	This Ceiling-Mounted Indicator Module (EBCM) can be used with one of Litetronics' emergency battery backup products (EB10, EB10N or EB20) to provide a visual confirmation of the operational status of the EBB unit. This module is typically used in grid ceiling applications where it is recess mounted in a panel adjacent to the fixture.
EBAM	Adhesive-Mounted Indicator Module	This Adhesive-Mounted Indicator Module (EBAM) must be used with one of Litetronics' emergency battery backup products (EB10, EB10N or EB20) to provide a visual confirmation of the operational status of the EBB unit. This module is typically used in open ceiling or drywall ceiling applications where the module is applied to the side of the fixture, mounting kit, or a nearby structural element.



ORDERING INFORMATION

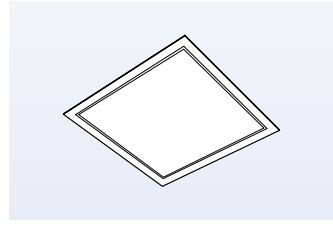
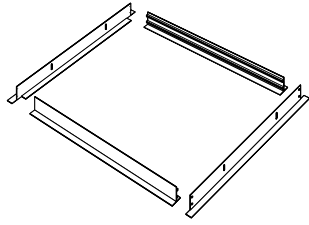

DRYWALL MOUNT KIT

MODEL #	DESCRIPTION	USAGE	OUTSIDE DIMENSIONS
FPAM224	2x4 Drywall Mount Kit	Recess mount 2x4 Panels in ceiling surfaces	47.85" x 23.94" x 2.44"
FPAM222	2x2 Drywall Mount Kit	Recess mount 2x2 Panels in ceiling surfaces	24.07" x 23.94" x 2.44"
FPAM221	1x4 Drywall Mount Kit	Recess mount 1x4 Panels in ceiling surfaces	47.85" x 11.97" x 2.44"

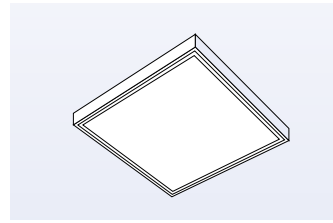
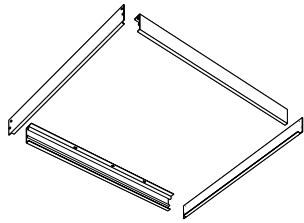

SURFACE MOUNT KIT

MODEL #	DESCRIPTION	USAGE	OUTSIDE DIMENSIONS
PTAM204	2x4 Surface Mount Kit	Surface mount 2x4 Panels to ceiling surfaces	47.85" x 23.94" x 3.1875"
PTAM202	2x2 Surface Mount Kit	Surface mount 2x2 Panels to ceiling surfaces	24.07" x 23.94" x 3.1875"
PTAM301	1x4 Surface Mount Kit	Surface mount 1x4 Panels to ceiling surfaces	47.85" x 11.97" x 3.1875"



Cable Length is 5'

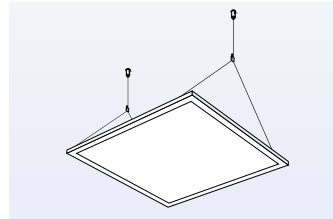

SUSPENSION MOUNT KIT

MODEL #	DESCRIPTION	USAGE	WEIGHT RATING	MAX DISTANCE FROM CEILING
PTAM214	2x4 Suspension Mount Kit	Suspend 2x4 Panels from ceiling	25 lbs	4.45'
PTAM212	2X2 Suspension Mount Kit	Suspend 2x2 Panels from ceiling	25 lbs	4.45'
PTAM211	1X4 Suspension Mount Kit	Suspend 1x4 Panels from ceiling	25 lbs	4.45'