

PROJECT:	
CATALOG #	
TYPE:	DATE:

LED AREA LIGHT

DESCRIPTION

Litetronics LED Area Lights are available in three models from 100W through 300W, each with three field-selectable wattages and CCT (3000K, 4000K and 5000K). The unit is offered with 3-pin shorting cap, and Type III distribution (Type II, IV, & V distributions available). Optional sensors include PIR (SC005), Microwave (SC006) and our LiteSmart Bluetooth Sensor (SC015) provides energy-saving control capabilities, with the added advantage of group-level setup and management through the LiteSmart mobile app, thereby ensuring compliance with code requirements and local ordinances.

In addition, Litetronics offers optional slipfitter, direct, and trunnion mountings.



FEATURES

- Optional slipfitter, direct, and trunnion mountings available
- Type III distribution (Type II, IV, & V distributions optional)
- 3-pin shorting cap (standard-included)
- Optional glare shields to meet code and local ordinance
- Pluggable sensor socket
- Compatibility with LiteSmart mobile app
- Field selectable wattages and CCT (3000K, 4000K, 5000K)
- 50,000-hour rated life
- 5-year warranty
- DLC 5.1 Premium

MARKETS

- Car dealership
- Schools, campuses, day care
- Parking lots
- Commercial
- Transportation hubs
- Trucking Depots
- Retail
- Event Centers
- Industrial yards and lots

MOUNTING

- Slipfitter
- Direct
- Trunnion

CERTIFICATIONS



SPECIFICATIONS

Life (@L70): 50,000 hours

Warranty: 5 years

PERFORMANCE

Operating temp: -40F to 122°F (-40°C to 50°C)

Efficacy (LPW): 140

CRI: 80

ELECTRICAL

Input voltage: 120-277V, 277-480V

Input frequency: 50/60Hz

PF: ≥.95

THD: ≤ 20%

Surge protection: 10KV (20KV Accessory Option)

Dimming: 0-10V

Minimum dimming: N/A

Aux. Voltage: N/A

Driver Class - AL1503: Class P

AL2003: Class P

AL3003: Class P

Whip/Cord: 3.5'

Sensor: Plug-In (Choice of MW, PIR, Bluetooth)

OPTICAL

Beam: 155°

Lens: Polycarbonate Frosted

UGR: N/A

PHYSICAL

Finish: Matte Powder Coat

Color: Dark Bronze

Housing: Painted Steel

INDUSTRY STANDARDS/RATINGS

Bug Rating

AL1503: B3-U0-G3

AL2003: B3-U0-G3

AL3003: B3-U0-G3

IP: 65

IK: N/A

Location: Wet

Outdoor Rated: Yes

IC: No

UL/ETL: UL

FCC: Yes

RoHS: Yes

DLC: 5.1 Premium

MOUNTING

Optional: Slipfitter, Trunnion, and Direct mounting available

DIMENSIONS / WEIGHT

ORDER#	LENGTH	WIDTH	HEIGHT	WEIGHT
AL1503	15.7"	10.4"	3"	12.78 lbs.
AL2003	18.8"	13.1"	3"	19.40 lbs.
AL3003	18.8"	13.1"	3"	19.40 lbs.

AL1503

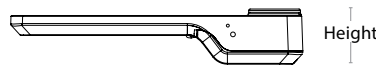

Length

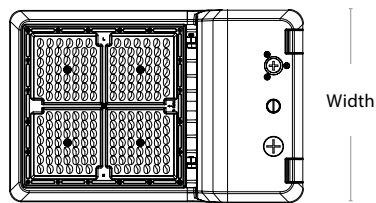

Width

Note: Lens are rotatable. See installation instructions for details.

AL2003/AL3003

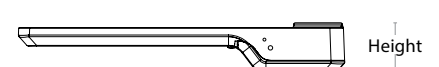

Length

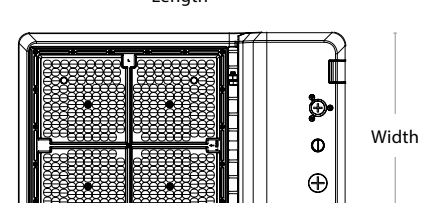

Width

ORDERING INFORMATION

Listed below are the selectable wattage settings and lumens for each model number.

AL1503



AL2003/AL3003

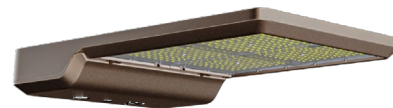

ORDERING CODE	DESCRIPTION	WATTS	VOLTS	CCT (K)	LUMENS
AL1503	Area Light	100 125 150	120-277V	3000 4000 5000	14,000 17,500 21,000
AL2003	Area Light	150 175 200	120-277V	3000 4000 5000	21,000 24,500 28,000
AL3003	Area Light	240 270 300	120-277V	3000 4000 5000	33,600 37,800 42,000

HIGH VOLTAGE

ORDERING CODE	DESCRIPTION	WATTS	VOLTS	CCT (K)	LUMENS
AL1503HV	Area Light	100 125 150	277-480V	3000 4000 5000	14,000 17,500 21,000
AL2003HV	Area Light	150 175 200	277-480V	3000 4000 5000	21,000 24,500 28,000
AL3003HV	Area Light	240 270 300	277-480V	3000 4000 5000	33,600 37,800 42,000

ACCESSORIES



SENSORS & CONTROLS

ORDERING CODE	DESCRIPTION	USAGE
SC005	Plug-in PIR Sensor	Enable occupancy sensing on pluggable fixtures.
SC015	Plug-In Bluetooth PIR Sensor with IR for Outdoor	This sensor enables wireless control of fixtures, or groups of fixtures, through the LiteSmart mobile app.
SCR053	Remote Control	Used (with SC005 sensor) to adjust settings after installation.
SCR054	Remote Control	Used to Commission LiteTronics "Next Generation" LiteSmart IR-Enabled Sensor.
OLAPC	3-pin Photocontrol for Outdoor Light	Photocontrol for 120-480V, IP65, black. Enables fixture to turn on/off based on daylight levels.

FIXTURE MOUNTS

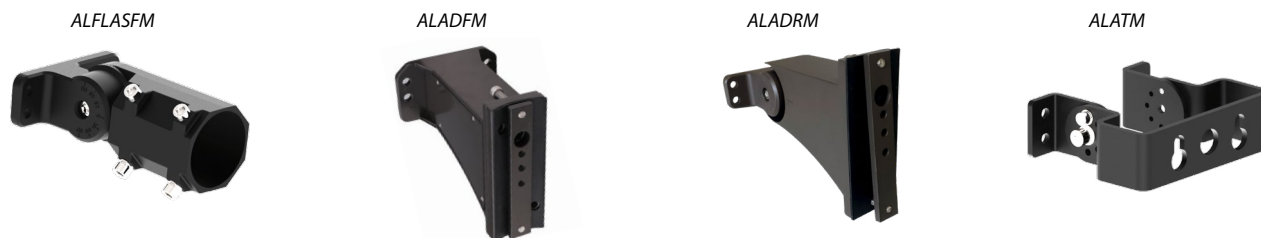

MOUNTS

ORDERING CODE	DESCRIPTION	USAGE
ALFLASFM	Area Light/Flood Light Slipfitter Mount	For use with area light 150-300W and flood light 100-150W product only.
ALADFM	Area Light Direct Fixed Mount	For use with 150W, 200W and 300W area lights.
ALADRM	Area Light Direct Rotatable Mount	For use with 150W, 200W and 300W area lights
ALATM	Area Light Trunnion Mount	For use with 150W, 200W and 300W area lights

SLIPFITTER

ORDERING CODE	DEPTH	INTERNAL DIAMETER
ALFLASFM	3.5"	2.44"

Note: Minimum recommended tenon length of 6".

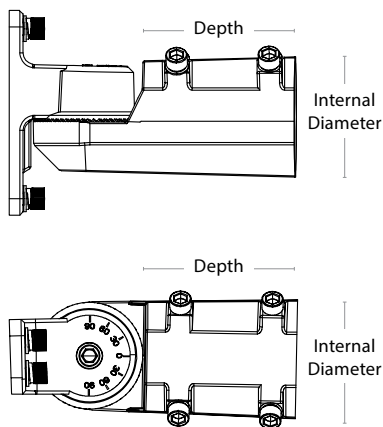

FIXTURE POLE CONFIGURATION AND EPA WIND RATING

From single to double to quad configurations, Litetronics Area Lights can accommodate the needed number of fixtures per pole to meet all application needs.

PRODUCT	FIXTURE POSITION						
		Single Fixture	2 Fixtures at 90°	2 Fixtures at 180°	3 Fixtures at 90°	3 Fixtures at 120°	4 Fixtures at 90°
150W	Horizontal	0.384	0.599	.0776	0.914	0.983	0.914
	45°	1.344	1.831	1.344	2.328	3.281	2.328
200W / 300W	Horizontal	0.468	0.73	0.945	1.114	1.198	1.114
	45°	2.016	1.831	1.344	2.328	3.281	2.328

Note: Litetronics does not manufacture or sell poles.

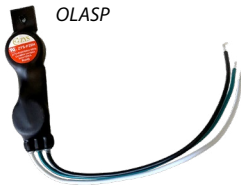

SURGE PROTECTOR

ORDERING CODE	DESCRIPTION	USAGE
OLASP	Surge Protector 20KV	Used for applications that need increased surge protection for 277-480V.



GLARE SHIELDS

ORDERING CODE	DESCRIPTION
ALAGS1	Area Light Glare Shield for 150 watts.
ALAGS2	Area Light Glare Shield for 200/300 watts.

ACCESSORY LENS

ORDERING CODE	DESCRIPTION
ALAL1502	Area Light Accessory Lens for use with 150W product Type II
ALAL3002	Area Light Accessory Lens for use with 200W/300W product Type II
ALAL1503	Area Light Accessory Lens for use with 150W product Type III
ALAL3003	Area Light Accessory Lens for use with 200W/300W product Type III
ALAL1504	Area Light Accessory Lens for use with 150W product Type IV
ALAL3004	Area Light Accessory Lens for use with 200W/300W product Type IV
ALAL1505	Area Light Accessory Lens for use with 150W product Type V
ALAL3005	Area Light Accessory Lens for use with 200W/300W product Type V

Note: Field swap and installation allowed.

WIRELESS CONTROL WITH PLUGGABLE SENSORS



LITESMART



LiteSmart is a mobile app that enables total management of lighting systems at the touch of your fingers. Within the app, all functionality can be set up and controlled; on/off, dimming, grouping, scene creation and time scheduling. Adjustments can also be made to the occupancy sensor settings, then implemented across an entire group in seconds.

- Total control over your lighting system
- Quick and easy changes that can be implemented in seconds across a group of fixtures
- Further energy reduction via occupancy sensing, and max wattage control
- Ability to create custom scenes based on specific needs, such as presentations
- Time scheduling that sets hours of operation per day



The smart PIR sensor uses a remote control (SCR054) to Commission and group Litetronics "Next Generation" LiteSmart IR-Enabled SC011 Sensor.



Set up and manage your space with LiteSmart.

Disclaimer: Specifications are subject to change without notice. While Litetronics makes every effort to ensure accuracy, we do not guarantee the completeness or reliability of the information provided. For the most current product data, please visit www.litetronics.com.

Litetronics, Inc. | 6969 W. 73rd St. Bedford Park, IL 60638 | Tel:1-800-860-3392 | customerservice@litetronics.com

www.Litetronics.com