

PROJECT:	
CATALOG #	
TYPE:	DATE:

LED AREA LIGHT

DESCRIPTION

Litetronics LED Area Lights are available in three models from 100W through 300W, each with three field-selectable wattages and CCT (3000K, 4000K and 5000K). The standard unit is offered with slipfitter mounting, 3-pin shorting cap, pluggable sensor socket, and Type III distribution (Type II, IV, & V distributions available). Optional Sensors include PIR (SC005), Microwave (SC006) and our LiteSmart Sensor (SC008) enabling the same energy saving control but can be setup and managed on a group level via the LiteSmart mobile app to meet code and local ordinance.

In addition to standard slipfitter, Litetronics offers optional trunnion, yoke, direct and universal mountings.



FEATURES

- Slipfitter mount standard (trunnion, yoke, direct and universal mountings optional)
- Type III distribution (Type II, IV, & V distributions optional)
- 3-pin shorting cap (standard-included)
- Optional Shields to meet code and ordinance
- Pluggable sensor socket
- Compatibility with LiteSmart mobile app
- Field selectable wattages and CCT (3000K, 4000K, 5000K)
- 50,000-hour rated life
- 5-year warranty
- DLC 5.1 Premium (pending)

MARKETS

- Car dealership
- Schools, campuses, day care
- Parking lots
- Commercial
- Transportation hubs
- Trucking Depots
- Retail
- Event Centers
- Industrial yards and lots

MOUNTING

- Slipfitter
- Trunnion
- Yoke
- Direct
- Universal Mountings

CERTIFICATIONS



SPECIFICATIONS

Life (@L70): 50,000 hours

Warranty: 5 years

PERFORMANCE

Operating temp: -40F to 122°F (-40°C to 50°C)

Efficacy (LPW): 140

CRI: 80

ELECTRICAL

Input voltage: 120-277V (480V option MTO)

Input frequency: 50/60Hz

PF: ≥.95

THD: ≤ 20%

Surge protection: 10KV (20KV Accessory Option)

Dimming: 0-10V with LiteSmart Bluetooth control system

Minimum dimming: N/A

Aux. Voltage: N/A

Driver Class - AL1503: Class P

AL2003: Class P

AL3003: Class P

Whip/Cord: 3.5'

Sensor: Plug-In (Choice of MW, PIR, Bluetooth)

OPTICAL

Beam: 155°

Lens: Polycarbonate Frosted

UGR: N/A

PHYSICAL

Finish: Matte Powder Coat

___ MIL Thickness

Color: Dark Bronze

Housing: Painted Steel

INDUSTRY STANDARDS/RATINGS

Bug Rating

AL1503: B3-U0-G3

AL2003: B3-U0-G3

AL3003: B3-U0-G3

IP: 65

IK: N/A

Location: Wet

Outdoor Rated: Yes

IC: No

UL/ETL: UL (Pending)

FCC: Yes

RoHS: Yes

DLC: 5.1 Premium (Pending)

MOUNTING

Standard: Standard Slipfitter -
Tilt knuckle setting 0-90

Optional: Trunnion, Yoke, Direct,
Universal mounting

DIMENSIONS / WEIGHT

ORDER#	LENGTH	WIDTH	HEIGHT	WEIGHT
AL1503	22.6"	10.4"	3.31"	15.87 lbs.
AL2003	25.7"	13.1"	3.31"	22.49 lbs.
AL3003	25.7"	13.1"	3.31"	22.49 lbs.

AL1503

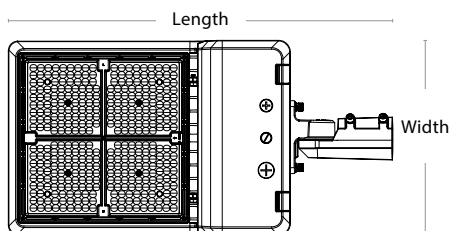
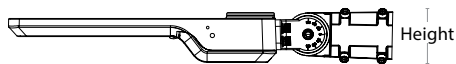

AL2003/AL3003

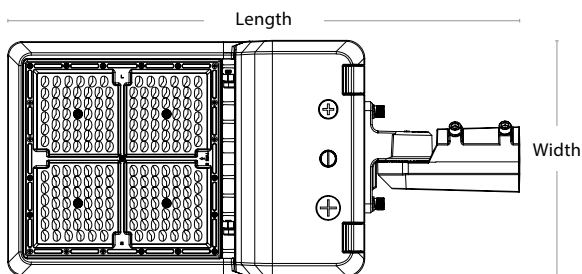
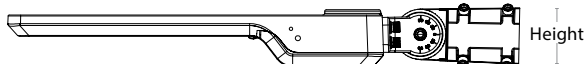

Note: Lens are rotatable. See installation instructions for details.

SLIPFITTER

ORDER#	DEPTH	INTERNAL DIAMETER
ALFLASFM	3.5"	2.44"

Note: Minimum recommended tenon length of 6".

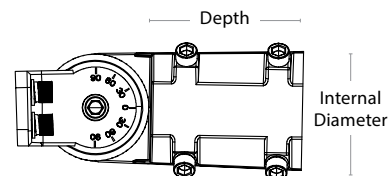
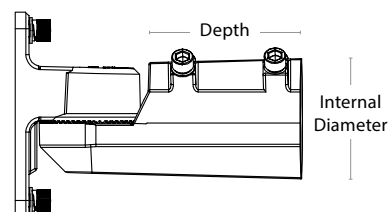

PRODUCT OVERVIEW AND INSTALLATION

STANDARD SLIPFITTER MOUNTING

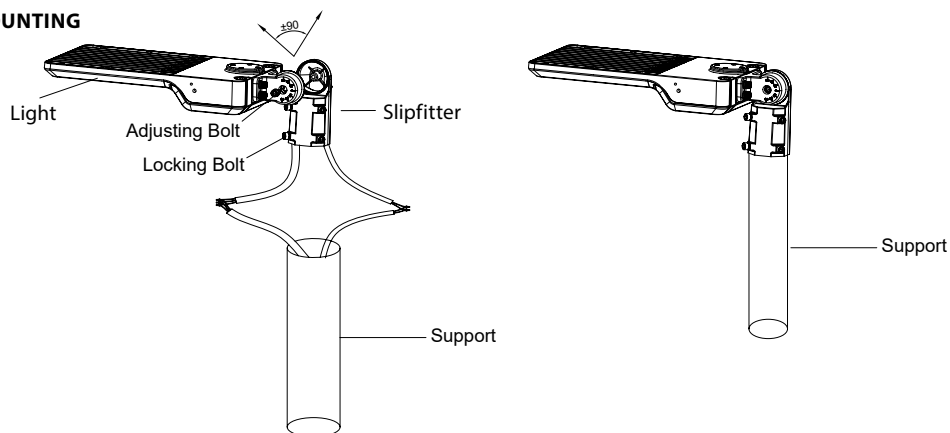

ORDERING INFORMATION

Listed below are the selectable wattage settings and lumens for each model number.

AL1503



AL2003/ AL3003

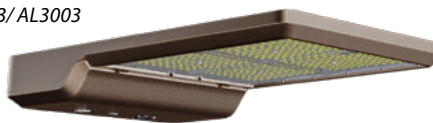

ORDERING CODE	DESCRIPTION	WATTS	VOLTS	CCT (K)	LUMENS
AL1503	Area Light	100 125 150	120-277V	3000 4000 5000	14,000 17,500 21,000
AL2003	Area Light	150 175 200	120-277V	3000 4000 5000	21,000 24,500 28,000
AL3003	Area Light	240 270 300	120-277V	3000 4000 5000	33,600 37,800 42,000

Note: High voltage available MTO (Made To Order).

ACCESSORIES

SC005



SC006



SCR053



SC008



SCR054



OLAPC1



SENSORS & CONTROLS

ORDERING CODE	DESCRIPTION	USAGE
SC005	Plug-in PIR Sensor	Enable occupancy sensing on pluggable fixtures.
SC006	Plug-in Microwave Sensor	Enable occupancy sensing on pluggable fixtures.
SCR053	Remote Control	Used (with SC005 and SC006 sensor) to adjust settings after installation.
SC008	Plug-in Bluetooth PIR Sensor with IR	This sensor enables wireless control of fixtures, or groups of fixtures, through the LiteSmart mobile app.
SCR054	Remote Control	Used to Commission LiteTronics "Next Generation" LiteSmart IR-Enabled Sensor.
OLAPC1	3-pin photocontrol	Photocontrol for 120-277V.
OLAPC2	3-pin photocontrol	Photocontrol for 277-480V (MTO Only) .

ACCESSORIES

ALADFM



ALADRM



ALATM



ALAYM1



ALAYM2



MOUNTS

ORDERING CODE	DESCRIPTION	USAGE
ALADFM	Area Light Direct Fixed Mount	For use with 150W, 200W and 300W area lights (MTO Only) .
ALADRM	Area Light Direct Rotatable Mount	For use with 150W, 200W and 300W area lights (MTO Only) .
ALATM	Area Light Trunnion Mount	For use with 150W, 200W and 300W area lights (MTO Only) .
ALAYM1	Area Light Yoke Mount	For use with 150W area lights (MTO Only) .
ALAYM2	Area Light Yoke Mount	For use with 200W and 300W area lights (MTO Only) .

OLASP



SURGE PROTECTOR

ORDERING CODE	DESCRIPTION	USAGE
OLASP	Surge Protector 20KV	Used for applications that need increased surge protection.

GLARE SHIELDS

ORDERING CODE	DESCRIPTION
ALAGS1	Area Light Glare Shield for 150 watts (MTO Only) .
ALAGS2	Area Light Glare Shield for 200/300 watts (MTO Only) .

WIRELESS CONTROL WITH PLUGGABLE SENSORS



The optional MW (SC006), and PIR Sensor (SC005) use a remote control for easy setup and control of individual fixtures.



The smart PIR sensor uses a remote control (SCR054) to Commission and group Litetronics "Next Generation" LiteSmart IR-Enabled SC008 Sensor.



LITESMART



LiteSmart is a mobile app that enables total management of lighting systems at the touch of your fingers. Within the app, all functionality can be set up and controlled; on/off, dimming, grouping, scene creation and time scheduling. Adjustments can also be made to the occupancy sensor settings, then implemented across an entire group in seconds.

- Total control over your lighting system
- Quick and easy changes that can be implemented in seconds across a group of fixtures
- Further energy reduction via occupancy sensing, and max wattage control
- Ability to create custom scenes based on specific needs, such as presentations
- Time scheduling that sets hours of operation per day



Set up and manage your space with LiteSmart.