

PROJECT:	
CATALOG #	
TYPE:	DATE:

SMART LED VOLUMETRIC TROFFER

WITH TUNABLE CCT

DESCRIPTION

Combining top-of-the-line efficiency with a sophisticated, architectural design, the LED Volumetric Troffer is an ideal solution for indoor commercial spaces, including grid ceiling applications.

The Smart Volumetric Troffer brings a new level of control and convenience to indoor lighting. Occupancy sensing and daylight harvesting capabilities automatically decrease energy use, and each feature can be customized to the preference of the occupants. Setup is easy with the LiteSmart mobile app, which enables group control, custom settings and scene configurations, all via bluetooth technology from your own mobile device.

Installation of the fixture is simple and quick; this LED troffer fits seamlessly into all standard 2' x 4', 2' x 2' or 1' x 4' grid ceiling layouts. It can also be surface and suspension mounted, or recessed into drywall ceilings. Each room or group of fixtures can be controlled via LiteSmart or by a wall mounted bluetooth switch.

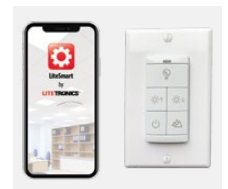
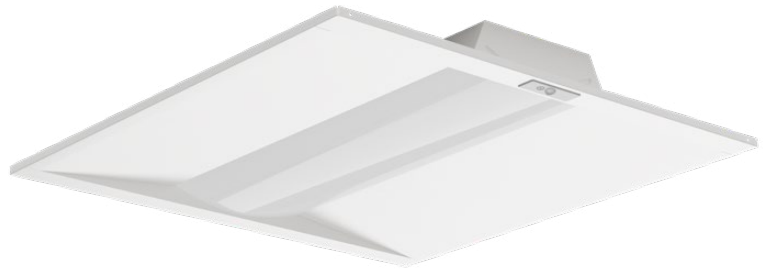

FEATURES

- Wireless setup and group control via LiteSmart mobile app
- Local control via bluetooth wall switch accessory
- Tunable CCT (3500 to 5000K)
- Top trim wattage control
- Occupancy sensing
- Daylight harvesting
- Custom scene configuration
- Time scheduling
- Continuous dimming
- DLC Premium (Pending)
- Size options: 2x4, 2x2, 1x4
- UL Damp location rating
- Compatible with Emergency Battery Backup
- 100,000-hour rated life
- 10-year warranty

MARKETS

- Schools and universities
- Offices and municipal buildings
- Healthcare facilities and hospitals

MOUNTING

- Grid ceiling
- Suspension
- Surface Mount
- Recessed drywall

CERTIFICATIONS



SPECIFICATIONS

Average rated life: 100,000 hours (@L70)
Warranty: 10 years
Operating temp: -4°F to 113°F (-20°C to 45°C)
Surge protection: ANSI C82.77 compliant
Input voltage: 120-277V
Input frequency: 50/60Hz
Power factor: ≥0.95
CRI: 80
Diffuser type: Polycarbonate frosted
Dimming: 0-10VDC ANSI C137.x compliant

Minimum dimming: 0% of rated lumen LED drive current
Location rating: Damp
UL listed: Yes
RoHS compliant: Yes
DLC rating: Premium (Pending)
IC rated: Yes
IP rating: 20

MOUNTING

Standard: T-bar grid (drop ceilings)
Wiring access: 1/2" trade size knockouts

ACCESSORIES

Emergency Battery Backup
Surface Mounting Kit
Drywall Mounting Kit
Suspension Mounting Kit

DIMENSIONS

SIZE	LENGTH	WIDTH	HEIGHT	WEIGHT
2' x 4'	47.75"	23.75"	2.875"	13.451 lbs
2' x 2'	23.75"	23.75"	2.875"	7.718 lbs
1' x 4'	47.75"	11.9"	2.875"	8.389 lbs

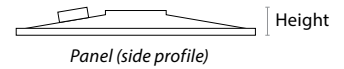
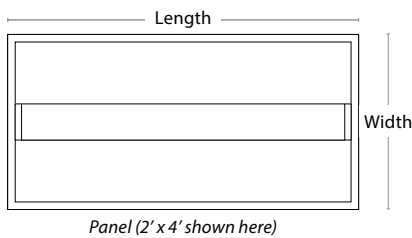

PRODUCT OVERVIEW AND INSTALLATION

STANDARD GRID CEILING MOUNTING

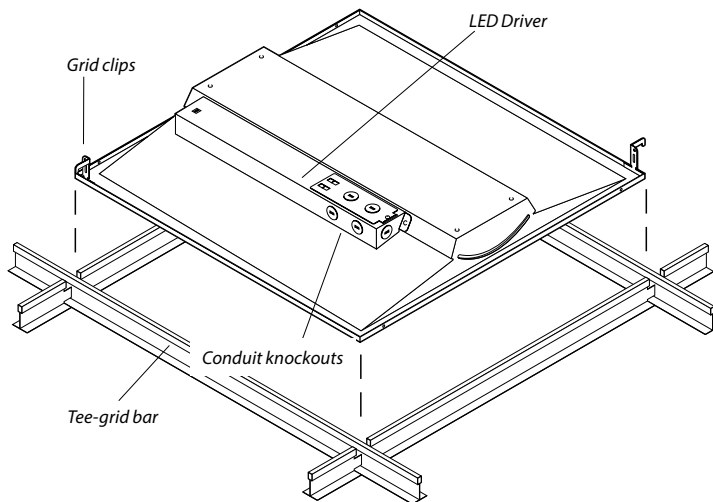

ALTERNATIVE MOUNTING OPTIONS

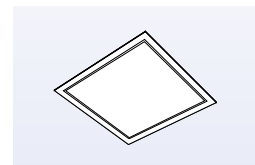

Recessed drywall mounted

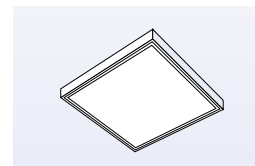

Surface mounted

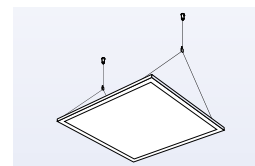

Suspension mounted

ORDERING INFORMATION

Listed below are the included wattage settings and lumens for each model number.



MODEL #	DESCRIPTION	SIZE	MAX WATTAGE	VOLTS	CCT	LUMENS
VLT4N	2x4 Smart LED Volumetric Troffer with Tunable CCT	2' x 4'	50	120-277	3500 to 5000K	6,250
VLT2N	2x2 Smart LED Volumetric Troffer with Tunable CCT	2' x 2'	36	120-277	3500 to 5000K	4,500
VLT1N	1x4 Smart LED Volumetric Troffer with Tunable CCT	1' x 4'	36	120-277	3500 to 5000K	4,500

BLUETOOTH CONTROL SWITCHES

MODEL #	DESCRIPTION	USAGE
BCS01	Bluetooth control switch (2 AA batteries not included)	Used to control functionality of the fixture; on/off, dimming, daylight harvesting and scene selection.
BCS02	Solar bluetooth control switch	Used to control functionality of the fixture; on/off, dimming, daylight harvesting and scene selection.



Note: Switches don't have CCT selectable capability.

ACCESSORIES

MODEL #	DESCRIPTION	USAGE
EB10N	10W Emergency Battery Backup	Supplies battery backup to an individual fixture for up to 90 minutes. Must be ordered with EBCM or EBAM indicator module.
EBCM	Ceiling-mounted Indicator Module	In grid ceiling applications, this unit connects to the EB10 and is recess mounted in an adjacent panel where it displays the unit's current status of operation.
EBAM	Adhesive-mounted Indicator Module	In drywall/open ceiling applications, this unit connects to the EB10 and is mounted via adhesive, where it displays the unit's current status of operation.
TR01	Test Remote Control	Used for testing and demonstrating the functionality of EB10 emergency battery backup integrated products. • Only one remote required per area, building or site as necessary.



DRYWALL MOUNT KIT

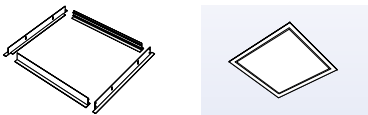

SURFACE MOUNT KIT

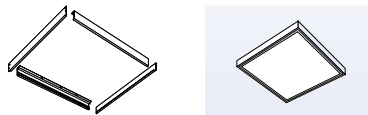

SUSPENSION MOUNT KIT



MODEL #	DESCRIPTION	USAGE	OUTSIDE DIMENSIONS
FPAM224	2x4 Drywall Mount Kit	Recess mount 2x4 Panels in ceiling surfaces	49.44" x 25.46" x 1.65"
FPAM222	2x2 Drywall Mount Kit	Recess mount 2x2 Panels in ceiling surfaces	25.46" x 25.46" x 1.65"
FPAM221	1x4 Drywall Mount Kit	Recess mount 1x4 Panels in ceiling surfaces	49.44" x 13.57" x 1.65"

MODEL #	DESCRIPTION	USAGE	OUTSIDE DIMENSIONS
PTAM204	2x4 Surface Mount Kit	Surface mount 2x4 Panels to ceiling surfaces	47.85" x 23.94" x 3.1875"
PTAM202	2x2 Surface Mount Kit	Surface mount 2x2 Panels to ceiling surfaces	24.07" x 23.94" x 3.1875"
PTAM301	1x4 Surface Mount Kit	Surface mount 1x4 Panels to ceiling surfaces	47.85" x 11.97" x 3.1875"

MODEL #	DESCRIPTION	USAGE	WEIGHT RATING	MAX DISTANCE FROM CEILING
PTAM214	2x4 Suspension Mount Kit	Suspend 2x4 Panels from ceiling	25 lbs	4.45'
PTAM212	2x2 Suspension Mount Kit	Suspend 2x2 Panels from ceiling	25 lbs	4.45'
PTAM211	1x4 Suspension Mount Kit	Suspend 1x4 Panels from ceiling	25 lbs	4.45'

WIRELESS CONTROL

The LED Smart Volumetric Troffer uses bluetooth technology for a completely wireless connection to your smart phone or remote wall switch.



Set up and manage your space with LiteSmart.

Use the remote switch for everyday control.



LITESMART
by Litetronics

LiteSmart is a mobile app that enables total management of lighting systems at the touch of your fingers. Within the app, all Smart LED Volumetric Troffer functionality can be set up and controlled, including power, dimming, grouping, scene creation and time scheduling. Adjustments can also be made to the occupancy sensor and daylight harvesting settings, then implemented across an entire group in seconds.

BENEFITS

- Total control over your lighting system
- Quick and easy changes that can be implemented in seconds across a group of fixtures
- Further energy reduction via occupancy sensing, daylight harvesting and max wattage control
- Ability to create custom scenes based on specific needs, such as presentations
- Time scheduling that sets hours of operation per day

A supplemental app, LiteBright, enables additional energy management functionality with the ability to set the max wattage of your fixtures.

NETWORK CAPABILITIES

- Unlimited admins and guests can be added to each network
- Each network supports up to 100 fixtures
- Individual fixtures can belong to up to 32 groups
- Up to 127 scenes can be created from one network
- Up to 10 switches can be created from one network



WIRELESS SWITCH
Part # BCS01 or BCS02

The bluetooth control switch comes in handy for the daily occupants of a space. This switch, which can be wall mounted, enables quick adjustments to be made to a specific group of fixtures. Features include on/off, dimming, daylight harvesting and scene selection. The switch must be set up through the LiteSmart mobile app, but can then function on it's own within any space.

BENEFITS

- Control over key functions for a specific group of lights
- Adjustments are quick and easy, and create an optimized space for a variety of needs
- Further reduce energy via daylight harvesting function, or disable daylight harvesting for full brightness
- Ability to choose between custom scenes based on specific needs within the space

SWITCH CAPABILITIES

- Enable/disable auto daylight harvesting
- Brighten/dim a group or turn on/off the entire group of fixtures
- Program up to 3 scenes per switch

HAVE QUESTIONS?

Our Customer Service team can help. Call us at 800-860-3392 or send an email to customerservice@litetronics.com