

# LITETRONICS®

## *LED Emergency Battery Backup*

### *Installation Instructions*

Ordering Code: EB40

---

#### **WHAT COMES IN THE BOX**

- (1) EB40 unit
- (1) Installation instructions
- (1) Charging indicator test switch with 2 screws
- (1) Test switch cover
- (2) Waterproof nuts
- (1) Remote control
- (11) Wire nuts

#### **TOOLS NEEDED**

- Wire stripper
- Wire cutter
- Phillips screwdriver
- Step ladder

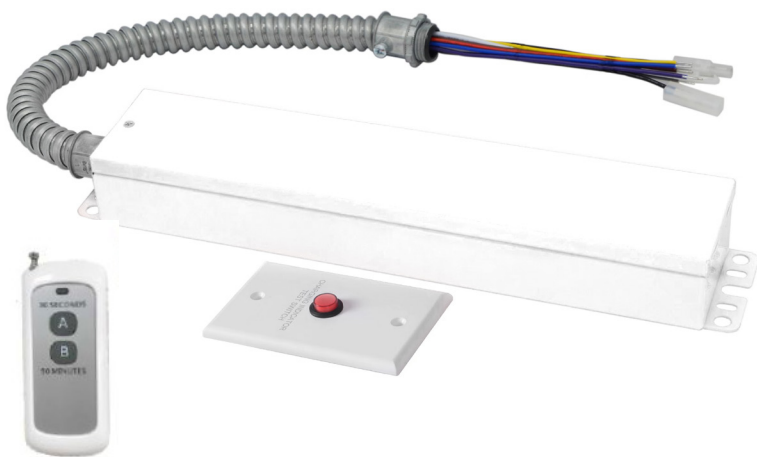

## SAFETY WARNING AND INSTRUCTIONS

---

When using electrical equipment, basic safety precautions should always be observed. Read and follow all safety instructions.

- Risk of fire or electric shock. Luminaire wiring and electrical parts may be damaged when drilling for installation of LED Emergency Backup. Check for enclosed wiring and components.
- Risk of fire or electric shock. This LED Emergency Backup installation requires knowledge of luminaire and electrical systems. If not qualified, do not attempt to install. Contact a qualified electrician.
- Before installation, make certain the AC power to the fixture is off.
- The electrical rating of this product is 100-347V Vac. Installer must confirm that there is 100-347V Vac to the fixture before installation.
- To prevent electrical shock, only mate unit connector after installation is complete and before the AC power to the fixture is back on.
- Do not use outdoors.
- This LED Emergency Backup unit requires an un-switched AC power source of 100-347V Vac, 50/60Hz.
- Do not let power supply cords touch hot surfaces.
- Do not mount near gas or electric heaters.
- Equipment should be mounted in locations and at heights where it is not subjected to tampering by unauthorized personnel. The use of accessory equipment is not recommended by the manufacturer and may cause an unsafe condition.
- Do not use this equipment for other than its intended use - only use for LED Lighting emergency backup.
- Use with grounded, UL/ETL listed, dry or damp location rated fixtures.
- CAUTION: The EB40 provides more than one power supply output source. To reduce the risk of electrical shock, disconnect both normal and emergency source by turning off the A.C. branch circuit.
- CAUTION: Servicing of this equipment should be performed by qualified personnel only.
- CAUTION: Do not attempt to service the battery. A sealed, no-maintenance battery is used that is not field replaceable. Replace the entire unit when necessary.
- CAUTION: The use of accessory equipment not recommended by the manufacturer may cause an unsafe condition, void warranty, and result in non-compliance with UL specifications.
- For use in 32°F minimum, to 122°F maximum ambient temperatures. Suitable for use in damp locations and plenum spaces.
- Not for use in heated air outlets or hazardous locations.

## COMPATIBILITY

---

The EB40 is compatible with all LED fixtures less than 300W. All fixtures must also include 0-10V dimming if wattage is greater than 40W.

**PLEASE NOTE:** Although tested and compliant with UL924, when used with a sensor-equipped fixture, unless the sensor wiring is accessible and bypassed, the sensor settings will remain active, overriding the EB40 emergency power to the fixture, and cause the fixture to dim or turn off based on its occupancy programming. This may not be ideal during emergency egress and may not meet code requirements. We recommend that if the EB40 is used on a sensor-equipped fixture, the sensor be programmed to maintain full light output when occupancy sensing or daylight harvesting is active.

# EB40 OPERATING INSTRUCTIONS

- Litetronics Emergency Battery Backup unit (EB40) delivers 90-minutes of power to fixtures in the event of a power outage.
- Once installed and receiving power, the unit will charge fully and remain in stand-by mode, and the indicator light will remain on.

## INDICATOR LIGHT

- In AC operation, the indicator light will remain on/solid
- In emergency operation, the light will flash slowly (on for 2 seconds, off for 2 seconds)
- If a failure were to occur, the light will flash quickly (on for 0.2 seconds, off for 0.2 seconds)
- The Indicator Light / Test Switch may be mounted on a switch box near the fixture. Although easy accessibility is not required, it must be visible to occupants.
- The Red Button/Indicator Light is required via Class 2 wiring to enable full functionality of the EB40.

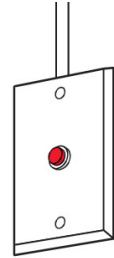

## TEST SWITCH

- In AC operation, press the test button once to conduct a 30 second emergency test
- In AC operation, press the test button twice (in 2 seconds timespan) to conduct a 90-minute full discharge test.
- During emergency operation, press the test switch once to shut off the unit

## REMOTE TEST SWITCH

- In AC operation, press test button A once to conduct a 30 second emergency test
- In AC operation, press test button B once (in 2 seconds timespan) to conduct a 90-minute full discharge test.
- During emergency operation, press the test switch once to shut off the unit
- Range - With the antenna extended, the range will be up to 40'.



## AUTOMATIC SELF-TESTING

- The EB40 includes a self-testing function, which will perform a 30-second discharge test once a month and a full discharge test one a year. At this time, the unit will simulate an AC power failure and automatically switch to emergency mode. During routine testing, the unit will monitor the operation of the LED load, battery voltage, an emergency duration. If the unit detects any problems, the indicator light will flash quickly.

## MAINTENANCE

Although no routine maintenance is required to keep the emergency battery backup functional, it should be checked periodically to ensure that it is working. The following schedule is recommended:

- Visually inspect the charge indicator light monthly. It should be illuminated.
- Test the emergency operation of the fixture at 30-day intervals for a minimum of 30 seconds.
- Conduct a 90-minute discharge test once a year. LED fixture should operate at up to 40W for at least 90 minutes.

## SERVICE

Should be performed as indicated above by qualified personnel.

# INSTALLATION

## BEFORE BEGINNING INSTALLATION, TURN OFF POWER AT THE CIRCUIT BREAKER.

1. Choose a location for the Emergency Battery Backup unit. The indicator light/ test switch should be mounted where they can be easily seen by inspectors.
2. The input voltage to the dimmable wires (DIM+, DIM-) of the EB40 must be less than 20Vdc.
3. Once mounted, select the appropriate wiring diagram to connect the EB40 to the AC driver. Use wirenuts to cap unused wires and make sure all connections are in accordance with the NEC and any local regulations.
4. Restore power to the fixture. When power is received, the red indicator light should appear, indicating that the unit is charging. An initial full charge could take up to 24 hours.

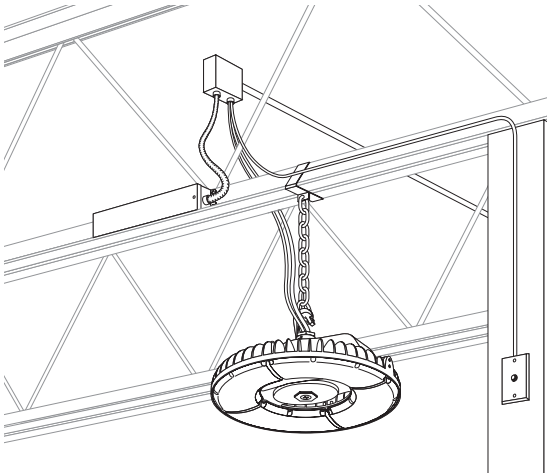

## WIRING DIAGRAMS

### When the LED driver power is less than the emergency power (40W)

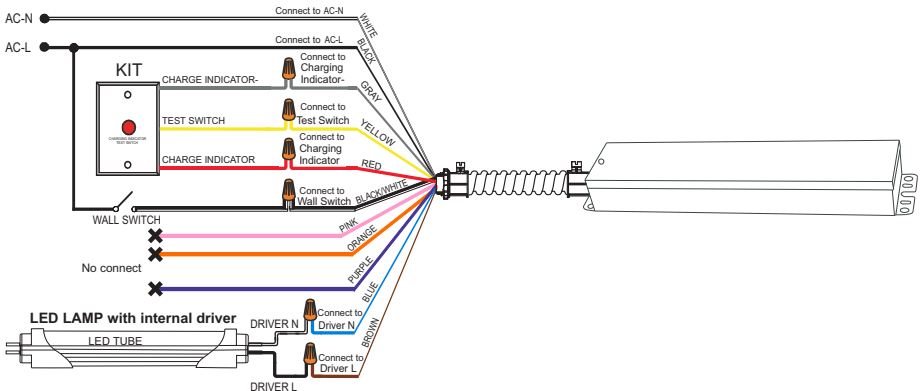

# When the LED driver power is greater than the emergency power (40W)

## A - With dimmer

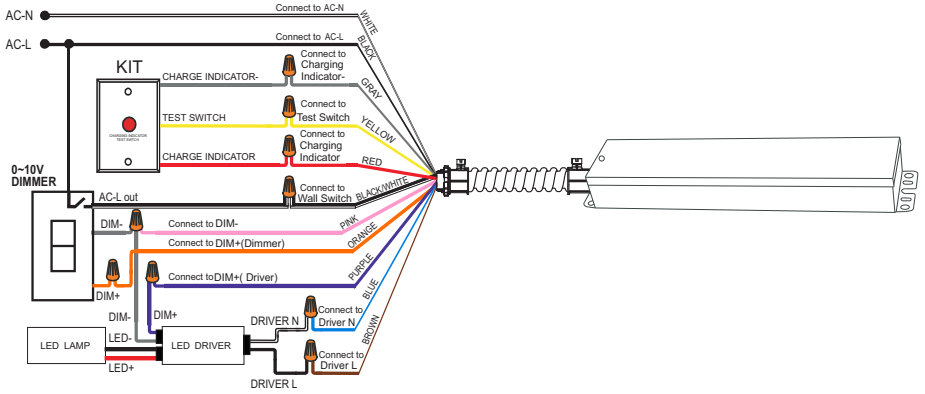

## B - Without dimmer

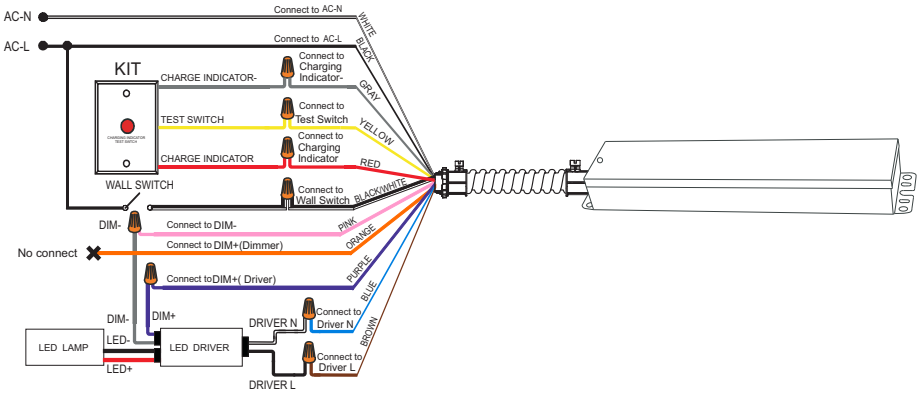

## C - Without switch & dimmer

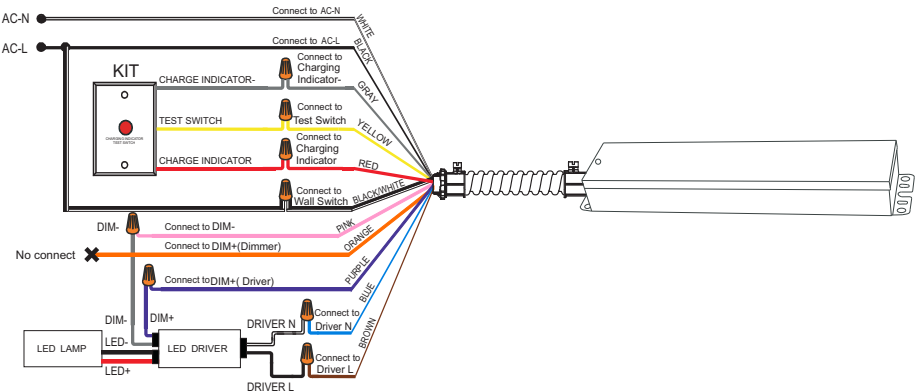





Thank you for choosing

**LITETRONICS®**

6969 W. 73rd Street  
Bedford Park, IL 60638

[www.Litetronics.com](http://www.Litetronics.com)

[CustomerService@Litetronics.com](mailto:CustomerService@Litetronics.com) or 1-800-860-3392



The information and product specifications contained in these instructions are based upon data believed to be accurate at the time of printing. This information is subject to change without notice and without incurring liability. If you have questions regarding specific product details, please contact us at 800-860-3392 or via email at [customerservice@litetronics.com](mailto:customerservice@litetronics.com).

To check for an updated version of these instructions, please visit [www.litetronics.com](http://www.litetronics.com).

9/6 /22 - V2.2