

LITETRONICS®

Suspension Mount Kit

Installation Instructions for Vapor Tight
For 4' (VTAM01) and 8' (VTAM02) LED Vapor Tight

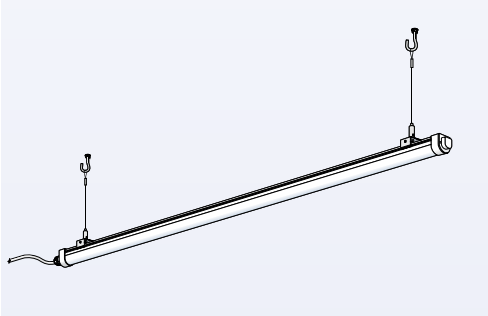

WHAT COMES IN THE SUSPENSION KIT PACKAGE

Vapor Tight Suspension Mount Kit comes with the following standard parts:

IMAGE	PART	VTAM01	VTAM02
A	Wires	2	3
B	Mounting Brackets	2	3
C	Screws	2	3
D	Cable Locks	2	3
E	Anti-spread Screws (M3 x 40)	2	3
F	Tooth Lock Washers (M3)	2	3
G	Anti-spread Nuts (M3)	2	3
H	Lock Washers for Hook	2	3
I	Washers for Hook	2	3
J	Nuts for Hooks	2	3
K	Expansion Hooks	2	3
L	Installation Instructions	1	1

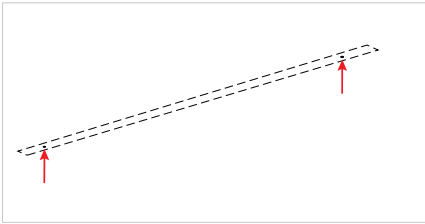
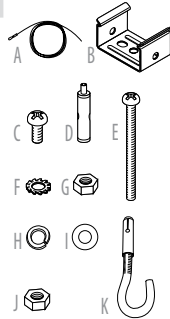

1. Turn off power. Determine mounting position and mark placement for expansion hooks. Drill pilot holes for anchors.

For 4' Installation- 2 holes required. (Extreme ends)

For 8' Installation- 3 holes required. (Extreme ends & center)

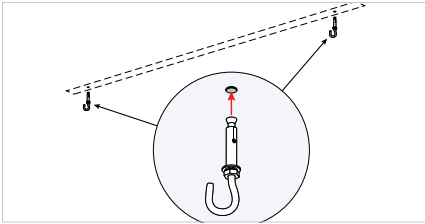

2. Insert the expansion hook into the surface by pressing firmly or gently hammering up to surface.

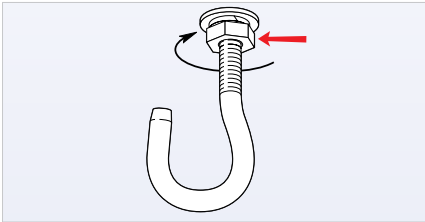

3. Tighten the hook nut to surface. The expansion will tighten inside surface.

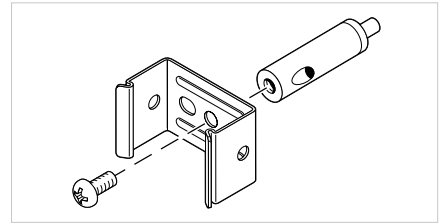

4. Insert screw through bottom of fixture bracket. Then tighten the cable lock to it.

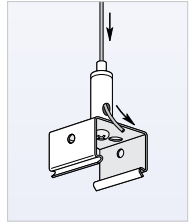
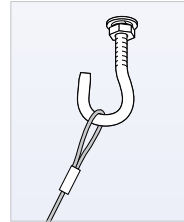

5. Hang wire loop over hook. Then feed the other end of wire through cable lock top until it comes out of the side. Adjust length accordingly for your fixture height.

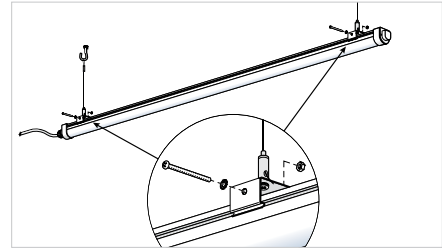

6. Attach both brackets to the Vapor Tight fixture. Secure brackets to fixture by using included anti-spread hardware. If needed, adjust wires until fixture is level. For Vapor Tight wiring, please refer to the installation instructions of Vapor Tight.

Before Installation, carefully remove all parts from the packaging.
Inspect product for defects due to shipping.