

LITE TRONICS®

LED Vapor Tight Slim Strip

Installation Instructions

For 4' and 8' LED Vapor Tight Slim Strip (VT Series)

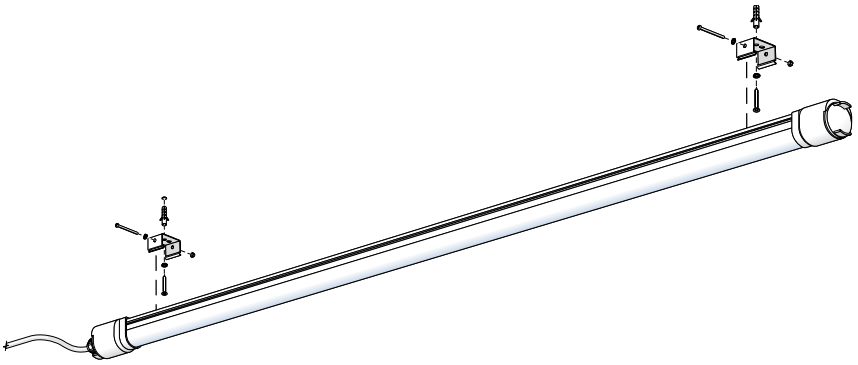

PLEASE READ THESE INSTRUCTIONS BEFORE INSTALLATION

SAFETY INSTRUCTIONS AND WARNINGS

WARNING:

READ CAREFULLY BEFORE INSTALLING STRIP LIGHT. RETAIN THESE INSTRUCTIONS FOR FUTURE REFERENCE.

CRITICAL SAFETY INSTRUCTIONS:

Installation should only be conducted by a qualified electrician in accordance with NEC and any relevant local building codes.

Risk of fire or electric shock. Strip Light installation requires knowledge of luminaires electrical systems. If not qualified, do not attempt installation. Contact a qualified electrician.

Be certain electrical power is OFF before and during installation and maintenance.

Strip Lights must be connected to a wiring system with an equipment-grounding conductor.

Make sure the supply voltage is the same as the rated Strip Lights voltage.

To prevent wiring damage or abrasion, do not expose wiring to edges of sheet metal or sharp objects.

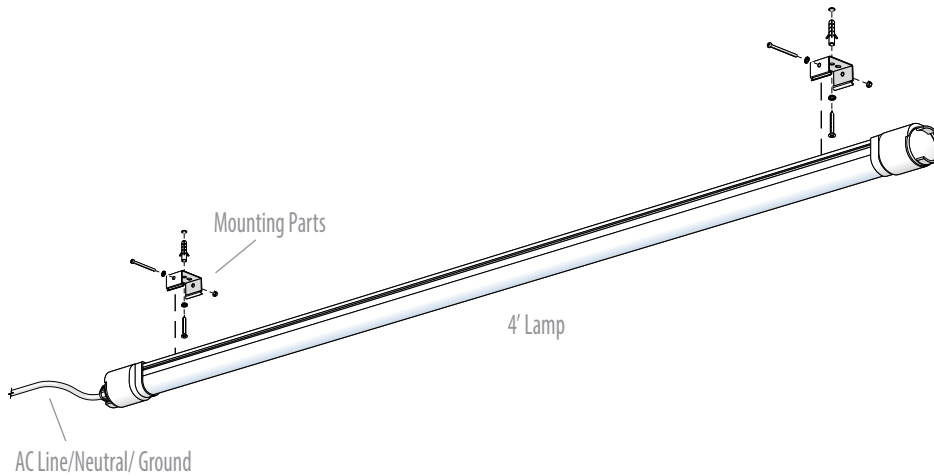

TOOLS TYPICALLY USED FOR INSTALLATIONS

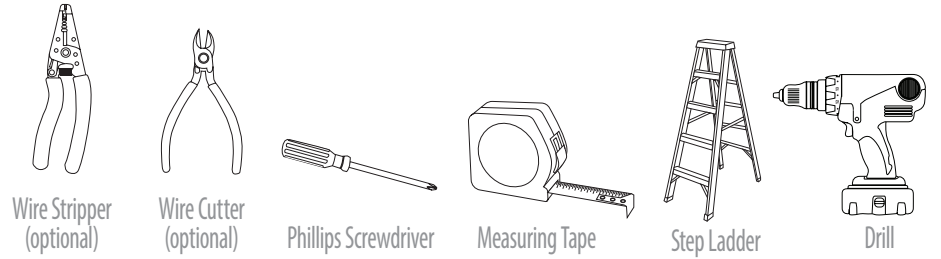

WHAT COMES IN THE BOX

LED Vapor Tight Slim Strip Light base product comes with following standard parts:

IMAGE	PART	4' QTY	8' QTY
A	LED Vapor Tight Slim Strip Light	1	1
B	Mounting Brackets	2	3
C	Anchors	2	3
D	Mounting Screws (#6 x 1 1/4")	2	3
E	Anti-spread Nuts	2	3
F	Anti-spread Screws (M3 x 40)	2	3
G	Tooth Lock Washers (M3)	2	3
H	Tooth Lock Washers (M4)	2	3
I	Installation Instructions	1	1
J	Connectable End Cap	1	N/A

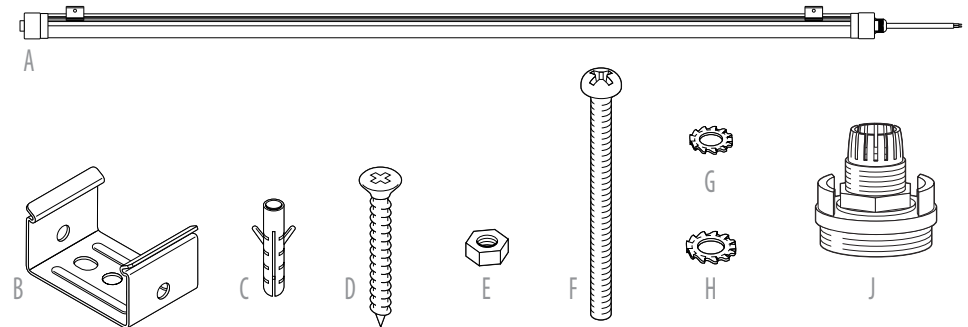

Before Installation, carefully remove all parts from the packaging.
Inspect product for defects due to shipping.

4' & 8' VAPOR TIGHT SLIM STRIP SURFACE MOUNT INSTALLATION

4' & 8' VAPOR TIGHT SLIM STRIP SURFACE MOUNT INSTALLATION

READ ALL INSTRUCTIONS BEFORE BEGINNING INSTALLATION

1. Turn off power at electrical panel.

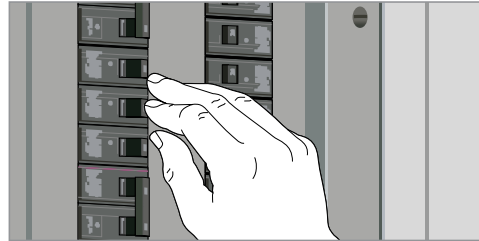

2. Determine mounting position and mark placement for brackets. Drill pilot holes for anchors.

Note:

For 4' Installation- 2 holes required. (Extreme ends)

For 8' Installation- 3 holes required. (Extreme ends & center)

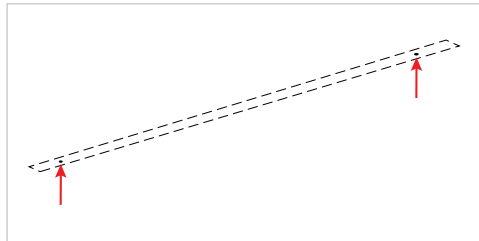

3. Insert the anchors into the surface by pressing firmly or gently hammering until anchors are level with surface.

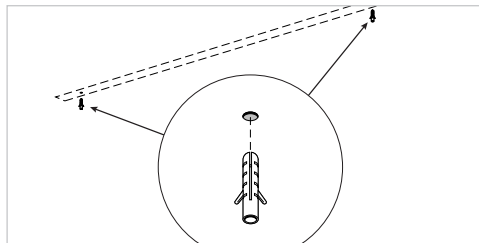

4. Place tooth lock washers (M4) over mounting screws (#6 x 1 1/4"), then through center hole of brackets and screw into anchors.

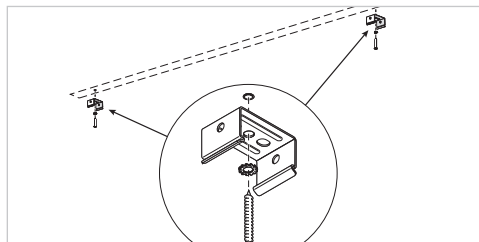

5. Tighten brackets down and be sure to align in same direction.

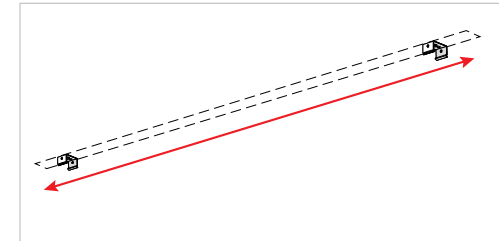

6. Place Vapor Tight Slim Strip Light into both brackets. They will snap into place. Slide into final position.

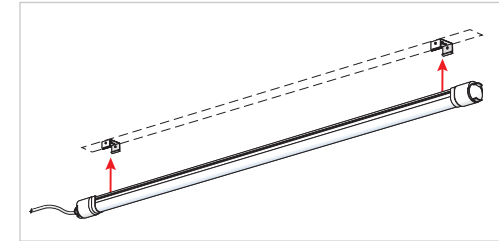

7. Use anti spread hardware to prevent fixture from moving after installation. Slide anti spread screw (M3 x 40) through tooth lock washers (M3). Then slide screw through holes in back of brackets.

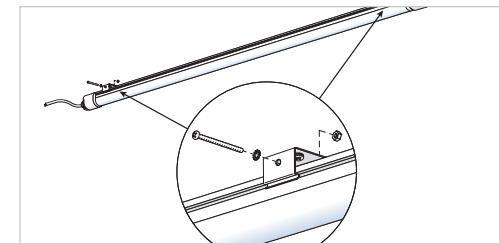

8. Thread anti spread nuts onto screws and tighten.

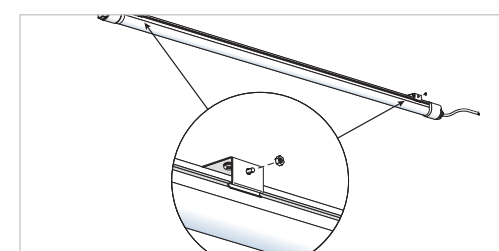

4' & 8' VAPOR TIGHT SLIM STRIP SURFACE MOUNT INSTALLATION

READ ALL INSTRUCTIONS BEFORE BEGINNING INSTALLATION

9. The fixture will now be firmly in place.

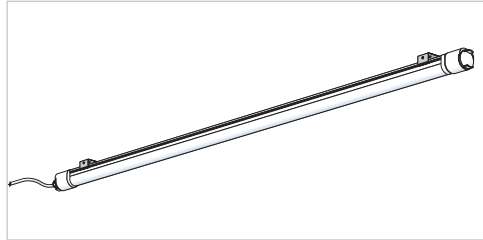

10. Using wire nuts (not included), connect incoming wires with fixture wires following wiring diagram below.

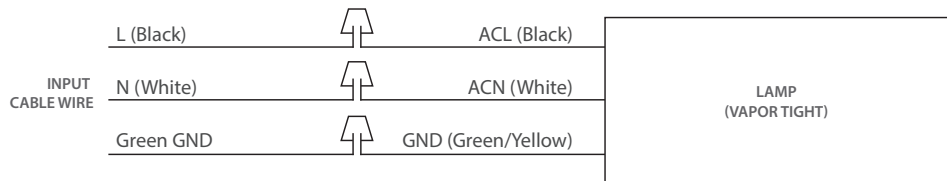

11. Turn on the power and you are done.

4' VAPOR TIGHT SLIM STRIP CONNECTING FIXTURE TO FIXTURE

The 4' model can be daisy chained, enabling coverage of a larger area from one power source. Follow the instructions below to connect one fixture to another.

Max number of fixtures that can be connected:

WATTS	MAX QUANTITY IN DAISY CHAIN
30	33

1. Unscrew the standard cap from fixture 1. The standard cap will be replaced with the connectable cap and will no longer be used.
2. Feed the wiring from fixture 2 into the connectable cap.
3. Make your connections between fixture 1 and 2 by inserting the live and ground wires into the quick connect.
4. Once wiring is complete, screw the connectable cap into fixture 1. Tighten the cap and lock nut as much as possible to ensure water/dust cannot seep in.
5. Continue this process for your entire daisy chain.

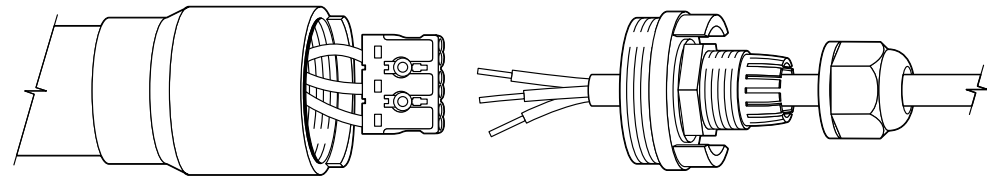

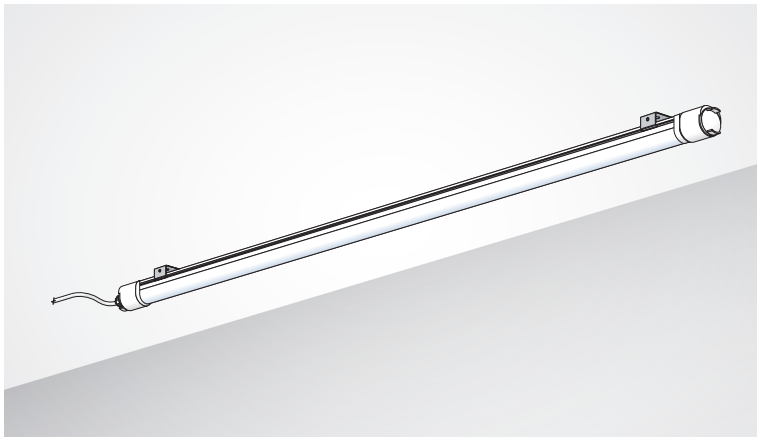

Thank you for choosing

LITETRONICS®

6969 W. 73rd Street
Bedford Park, IL 60638

WWW.LITETRONICS.COM

CustomerService@Litetronics.com or 1-800-860-3392



**RoHS
Compliant**

The information and product specifications contained in these instructions are based upon data believed to be accurate at the time of printing. This information is subject to change without notice and without incurring liability. If you have questions regarding specific product details, please contact us at 800-860-3392 or via email at customerservice@litetronics.com.

To check for an updated version of these instructions, please visit www.litetronics.com.

V6 (12/10/18)