

Pendant & Surface Mount Kit for LED Linear High Bay (LHBAM21)

Installation Instructions

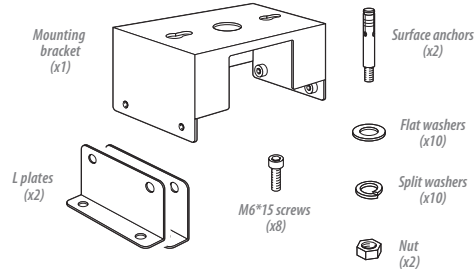

SAFETY INSTRUCTIONS AND WARNINGS

- When using electrical equipment, basic safety precautions should always be observed
- This product must be installed in accordance with the applicable installation code by a person familiar with the construction and operation of the product and the hazards involved
- Installation should only be conducted by a qualified electrician in accordance with NEC and any relevant local building codes.
- Be certain electrical power is OFF before and during installation and maintenance.
- To prevent wiring damage or abrasion, do not expose wiring to edges of sheet metal or sharp objects.

The information and product specifications contained in these instructions are based upon data believed to be accurate at the time of printing. This information is subject to change without notice and without incurring liability. If you have questions regarding specific product details, please contact us at 800-860-3392 or via email at customerservice@litetronics.com. To check for an updated version of these instructions, please visit www.litetronics.com.

WHAT COMES IN THE BOX

Mounting bracket (x1)	Flat washers (x10)
L Plates (x2)	Split washers (x10)
M6*15 screws (x8)	Nut (x2)
Surface anchors (x2)	

REQUIRED TOOLS

- 6 mm Metric Allen wrench for mounting cover
- Wire stripper
- Wire cutter

INSTRUCTIONS

Before installation, carefully remove all parts from the packaging. Inspect product for defects due to shipping.

1. Determine whether high bay will be surface or pendant mounted
Surface mounting - Mount surface anchors to ceiling structure. Then use 1 flat washer, 1 surface washer and 1 nut to secure the mounting bracket to the anchors.
Pendant mounting - Attach mounting bracket to conduit pipe.
2. Attach L plates to each side of the fixture using 1 M6*15 screw, 1 flat washer and 1 split washer. Do this for all 4 contact points.
3. Make wiring connections based on your product installation instructions.
4. Align fixture and L plates with already mounted bracket and secure with 1 M6*15 screw, 1 flat washer and 1 split washer. Do this for all 4 contact points.
5. Tighten all hardware. Your installation is now complete.

Surface mounting
Fig 1

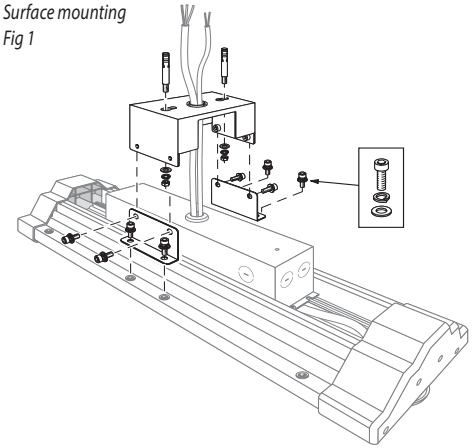

Pendant mounting
Fig 2

