

## LED LINEAR HIGH & LOW BAY



The LED Linear High and Low Bays deliver best-in-class efficiency (160LPW), durability and versatility, resulting in significant energy savings and zero maintenance over the life of the fixture. With five different lumen packages, ranging from 9,600 all the way up to 39,680 lumens, you can be sure to find an option that'll fit your space, regardless of ceiling height.

The Linear High Bay is available in 120-277V as well as 277-480V, and in a range of wattages. It comes standard with suspension cables, making it an easy upgrade from suspended fluorescent fixtures, but can also be pendant or surface mounted. It's extremely durable, constructed from extruded aluminum and fitted with a polycarbonate frosted lens.

For applications where motion sensing or daylight harvesting are needed, the LED Linear High Bay is the solution. Our built-in PIR sensor enables customization to fit your needs, adjusting settings such as brightness, sensitivity, daylight harvesting, etc. To further simplify the customization process, all settings can be adjusted from the ground via our Sensor Remote Control.

### KEY FEATURES

- 160 LPW
- DLC Premium
- Built-in PIR Sensor (optional)
- Damp location rated
- 100,000-hour rated life
- 10-year warranty
- 0-10V Dimming
- Universal 120-277V or 277-480V available

### MARKETS

- Warehouse & storage
- Industrial facilities
- Sports facilities & gyms
- Manufacturing facilities
- Retail centers

### APPLICATIONS

- High ceilings
- Task lighting



# ORDERING INFORMATION

Designed for ceiling heights 25' and above

WATTS	VOLTS	ORDERING CODE	DESCRIPTION	CCT (K)	LUMENS
88	120-277	LHB88UR240DLP	88W 120-277V Linear High Bay in 4000K	4000	14,000
		LHB88UR250DLP	88W 120-277V Linear High Bay in 5000K	5000	14,000
		LHB88UR250DLPS	88W 120-277V Linear High Bay in 5000K with sensor	5000	14,000
112		LHB112UR240DLP	112W 120-277V Linear High Bay in 4000K	4000	17,920
		LHB112UR250DLP	112W 120-277V Linear High Bay in 5000K	5000	17,920
		LHB112UR250DLPS	112W 120-277V Linear High Bay in 5000K with sensor	5000	17,920
148		LHB148US240DLP	148W 120-277V Linear High Bay in 4000K	4000	23,680
		LHB148US240DLPS	148W 120-277V Linear High Bay in 4000K with sensor	4000	23,680
		LHB148US250DLP	148W 120-277V Linear High Bay in 5000K	5000	23,680
		LHB148US250DLPS	148W 120-277V Linear High Bay in 5000K with sensor	5000	23,680
248		LHB248UV250DLP	248W 120-277V Linear High Bay in 5000K	5000	39,680
		LHB248UV250DLPS	248W 120-277V Linear High Bay in 5000K with sensor	5000	39,680
112	277-480	LHB112FR250DLP	112W 277-480V Linear High Bay in 5000K	5000	17,920
		LHB148FS250DLP	148W 277-480V Linear High Bay in 5000K	5000	23,680
		LHB148FS250DLPS	148W 277-480V Linear High Bay in 5000K with sensor	5000	23,680
		LHB248FV250DLP	248W 277-480V Linear High Bay in 5000K	5000	39,680
		LHB248FV250DLPS	248W 277-480V Linear High Bay in 5000K with sensor	5000	39,680

Designed for ceiling heights lower than 25'

WATTS	VOLTS	ORDERING CODE	DESCRIPTION	CCT (K)	LUMENS
60	120-277	LLB60UR250DLP	88W 120-277V Linear High Bay in 5000K	5000	9,600

## ACCESSORIES

ORDERING CODE	DESCRIPTION	USAGE
SCR053	REMOTE CONTROL FOR SENSOR	Used (on sensor model only) to adjust sensor settings after installation, from the ground. <ul style="list-style-type: none"> <li>Brightness - Set the output level (in %) of connected lighting during occupancy</li> <li>Sensitivity - Set the occupancy sensing sensitivity</li> <li>Hold time - Set the time that the sensor will hold after the area has been vacated</li> <li>Daylight harvesting - Set the threshold of natural light level</li> <li>Stand-by dim/time - Set the light level/time required after the hold time has elapsed</li> <li>Ability to pre-program 4 separate modes which can be saved and transferred from one fixture to another</li> </ul>



ORDERING CODE	DESCRIPTION	USAGE
LHBAGR	Linear High Bay Wire Guard 8.5 x 23.62	Used for added protection on 148W Linear High Bay

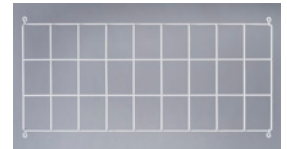

ORDERING CODE	DESCRIPTION	USAGE
LHBAM21	Pendant & surface mounting accessory for Linear High Bay	Used to pendant mount or surface mount the LED Linear High Bay



### EMERGENCY BATTERY BACKUP - COMPATIBLE WITH NON-SENSOR MODELS ONLY

ORDERING CODE	DESCRIPTION	USAGE
EB23UQB	23W 120-277V Emergency Battery Backup unit with 18" conduit	Used to supply the fixture with 23W of power in emergency situations



## SPECIFICATIONS

### Average rated life (@L70) and warranty based on operating temperature:

-4°F to 113°F = 100,000 hours | 10-year  
 -4°F to 122°F = 75,000 hours | 7-year  
 -4°F to 131°F = 50,000 hours | 5-year

**Surge protection:** ANSI C82.77 compliant

**Input voltage:** 120-277V or 277-480V

**Input frequency:** 50/60Hz

**Power factor:** ≥0.9

**Beam angle:** 110°

**CRI:** 80

**Standard dimming:** 0-10VDC ANSI C137.x compliant

**Minimum dimming:** 0% of rated lumen LED drive current

**Location rating:** Damp

**IP rating:** 42

**UL/cUL listed:** Yes

**RoHS compliant:** Yes

**DLC rating:** Premium

## MOUNTING

**Standard:** Suspension mounting

**Wiring access:** 1/2" trade size knockouts

**Additional options:** Pendant mounting

## ACCESSORIES

Remote control for sensor

Emergency Battery Backup

Pendant & surface mounting bracket

Wire guard for 148W model

## SIZING

WATTAGE	WIDTH	LENGTH	HEIGHT
60W	8.58"	15.75"	3.54"
88W	8.58"	15.75"	3.54"
112W	8.58"	15.75"	3.54"
148W	8.58"	23.62"	3.54"
248W	8.58"	35.42"	3.54"

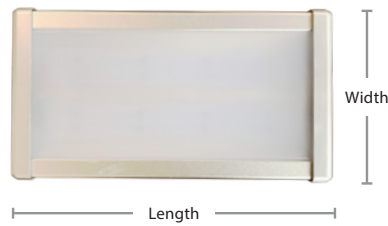

## PRODUCT OVERVIEW & STANDARD MOUNTING

### SUSPENSION MOUNTING TO ANCHORED HOOKS

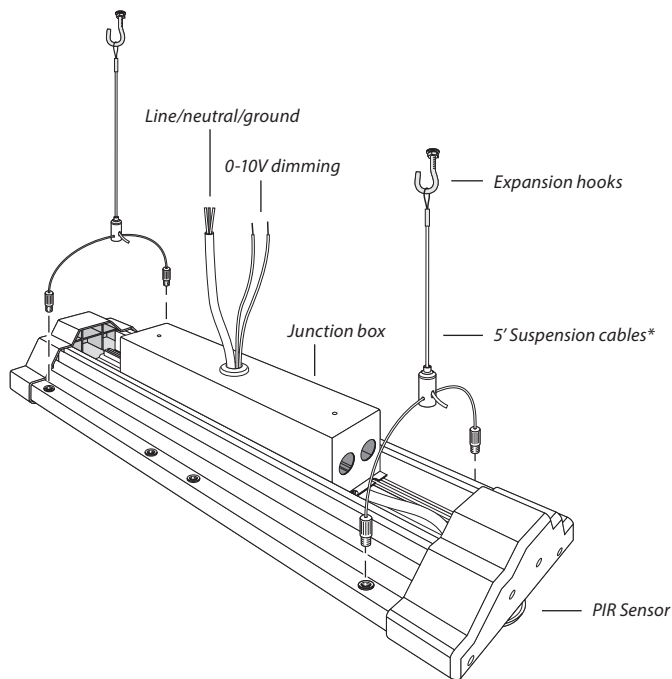

### SUSPENSION MOUNTING TO BEAM

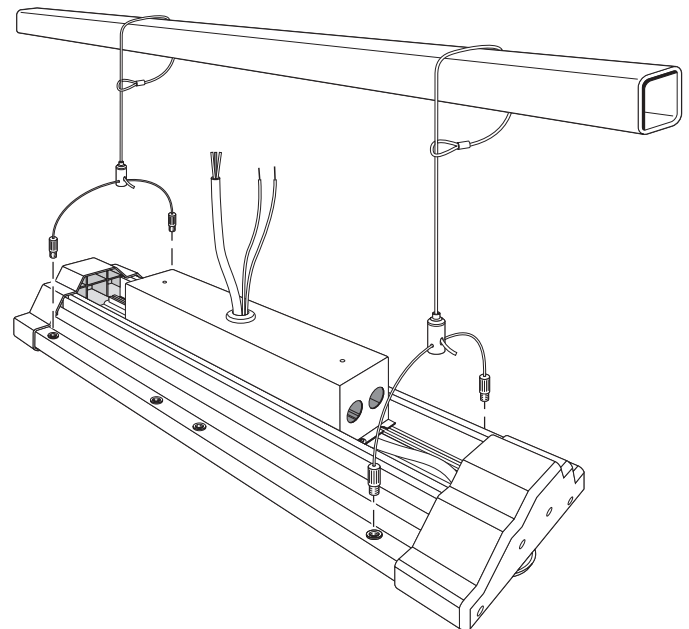

\*Suspension cables are included with the standard units

# ADDITIONAL MOUNTING OPTIONS

**SURFACE MOUNTING\***

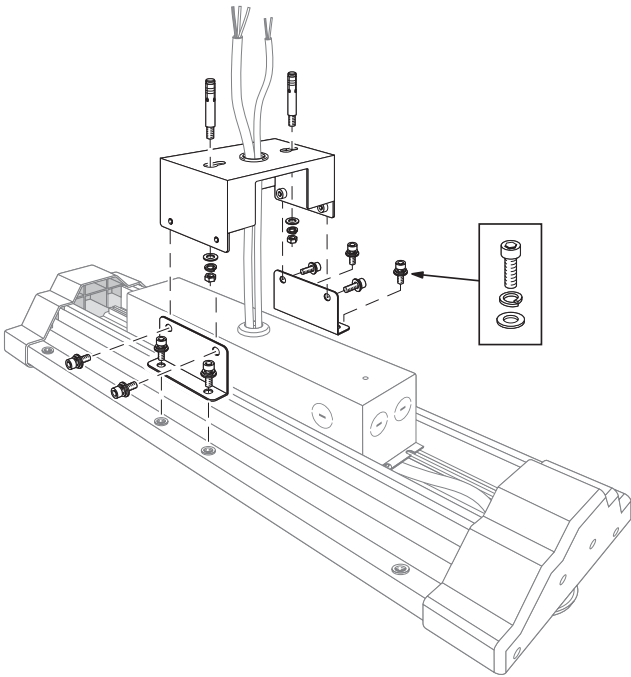

**PENDANT MOUNTING\***

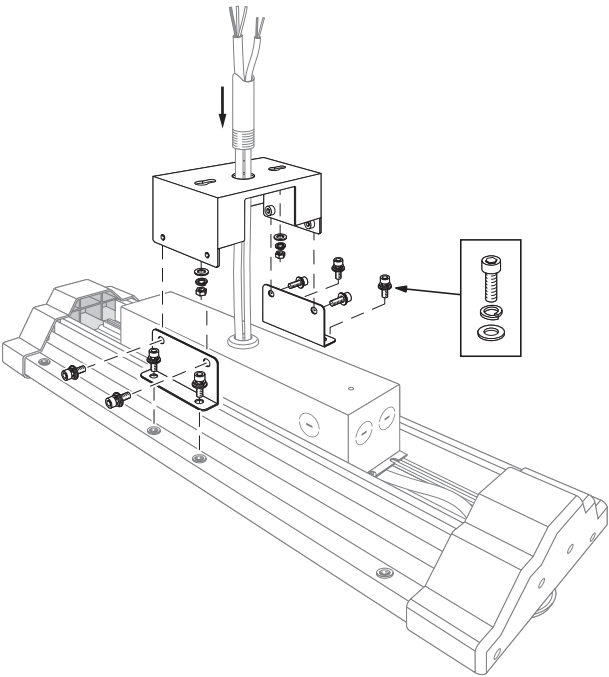

*\* Both surface and pendant mounting can be achieved with accessory LHBAM21 (listed on page 2)*